

2023
2024

Get Ready ▪ Get Set ▪ Go For It

Learn more about high school and plan for your success



Your
Detailed
High School
Course Guide



Calgary Board
of Education

Get Ready | CBE High Schools and Learning Centres

Schools are organized into seven administrative Areas. These seven administrative Areas use a feeder school model to more effectively support student transitions.

Based on where you live in the city, you are connected to a high school, which is your designated school.

Use the [Find a School](#) link to learn about your designated school or to learn the locations of programs of choice.

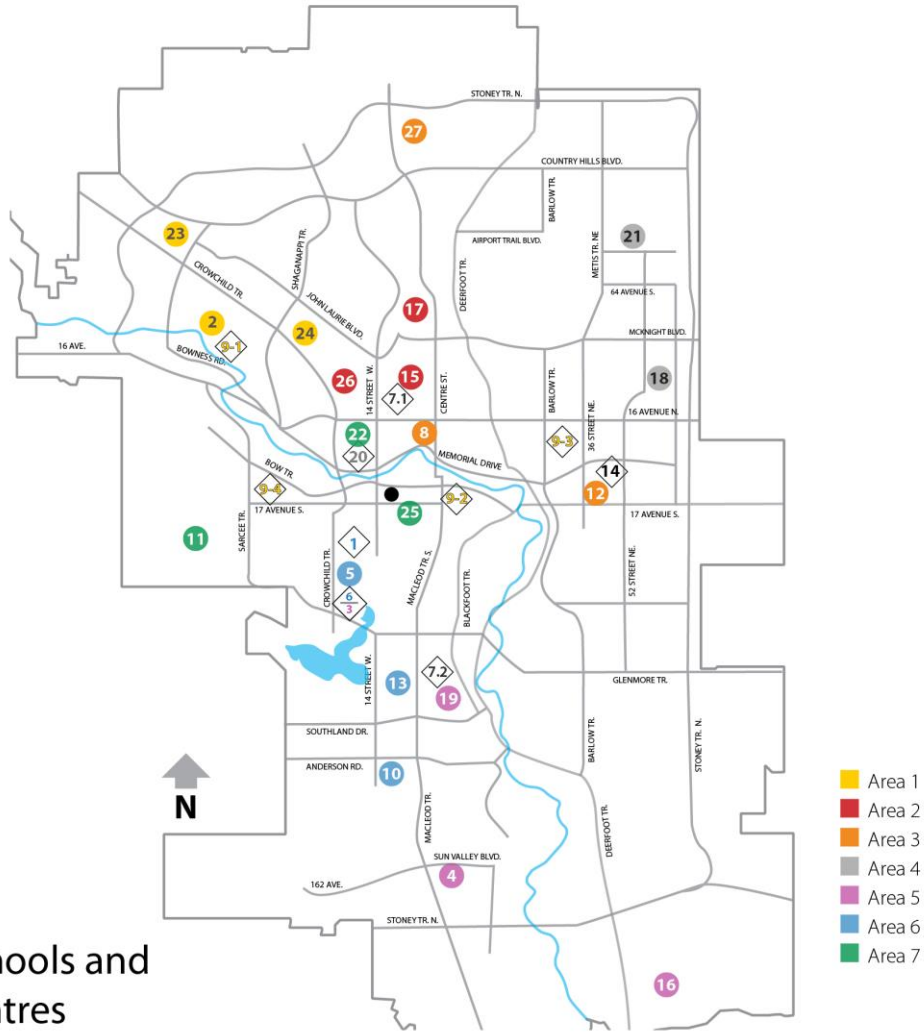

CBE High Schools and Learning Centres

- | | |
|--|--|
| 1 Alternative High School | 11 Ernest Manning High School |
| 2 Bowness High School | 12 Forest Lawn High School |
| 3 CBe-learn | 13 Henry Wise Wood High School |
| 4 Centennial High School | 14 Jack James High School |
| 5 Central Memorial High School | 15 James Fowler High School |
| 6 Career and Technology Centre | 16 Joane Cardinal-Schubert High School |
| 7 Chinook Learning Services | 17 John G. Diefenbaker High School |
| 7-1 North Campus at James Fowler HS | 18 Lester B. Pearson High School |
| 7-2 South Campus at Lord Beaverbrook HS | 19 Lord Beaverbrook High School |
| 8 Crescent Heights High School | 20 Louise Dean School |
| 9 Discovering Choices School (4 campuses) | 21 Nelson Mandela High School |
| 9-1 Bowness Start Outreach | 22 Queen Elizabeth High School |
| 9-2 Downtown Calgary Achievement Centre for Youth (CACY) | 23 Robert Thirsk High School |
| 9-3 Northgate Outreach | 24 Sir Winston Churchill High School |
| 9-4 Westbrook Outreach | 25 Western Canada High School |
| 10 Dr. E. P. Scarlett High School | 26 William Aberhart High School |
| ● Encore CBE | 27 North Calgary High School |
- ◇ Offers programming across the CBE
 ● A starting point for students returning to complete high school
 Contact your home high school for information about unique and specialized settings that have a placement process.

Table of Contents

Get Ready	1
Planning For Your Success	2
Choose Required Courses First	9
English Language Arts (ELA)	9
Mathematics (Math)	10
Science	12
Social Studies (Social)	13
Wellness CALM and PE	14
English Language Learning (ELL)	15
What to expect as an English Language Learner	15
Strengthen Communicative Competence With ELL Programming	15
Career and Technology Studies (CTS) and	19
Knowledge & Employability (K&E) Occupational Choices	19
Business, Administration, Finance & Information Technology (BIT)	21
Health, Recreation & Human Services (HRH)	23
Media, Design & Communication Arts (MDC)	26
Natural Resources (NAT)	28
Trades, Manufacturing & Transportation (TMT)	30
Innovation Technology Courses	33
Off-campus Education	34
Unique Pathways	36
Fine and Performing Arts Choices	36
CBE Fine and Performing Arts Certificate	36
Performing and Visual Arts (PVA)	36
Leadership in the Arts 35	36
An Overview of Fine and Performing Arts Courses	37
Dance	38
Drama	40
Music: Instrumental Music	42
Music: Choral Music	43
Music: General Music	44
Visual Arts	45
Languages Programs and Courses	47
French Language Arts (FLA / Immersion)	48
French as a Second Language (FSL)	49
Bilingual Programs and Courses	50
International Language and Culture Choices	51
Complementary Courses	53
Aboriginal Studies	53
English Language Arts (ELA)	54
Interdisciplinary	54
Learning Competencies	55
Mathematics	56
Science	56
Social Sciences	58
Unique Pathways & Off-campus Education	64
Internationally Recognized Course Offerings	67
Advanced Placement (AP)	68
International Baccalaureate (IB) Programme	73
International Opportunities	78
Summer School	79
Awards and Scholarships	80
Appendices	81
Appendix A Possible Course Sequences for a Certificate of High School Achievement	81
Appendix B Part 1 Course Sequences and Transfer Points	86
Appendix B Part 2 Knowledge and Employability Occupational Course Sequences	89
Appendix C CTS and K&E Occupational Pathways By High School Facilities	94
Appendix D Course Challenge – Questions and Answers	97
Appendix E Advanced Placement (AP) Courses by School and CBE Area	99

List of Tables

Table 1 My High School Program Planning	8
Table 2 ELL / ESL Courses and Language Proficiency Levels	17
Table 3 Locations for French Immersion and Spanish Bilingual Programs of Choice	47
Table 4 AP Schools by Area	67
Table 5 IB Programme	67
Table 6 Sample A Possible Course Sequences for a Certificate of High School Achievement	81
Table 7 Sample B Possible Course Sequence for a Certificate of High School Achievement	82
Table 8 Sample C Possible Course Sequence for a Certificate of High School Achievement.....	83
Table 9 Sample D Possible Course Sequence for a Certificate of High School Achievement.....	84
Table 10 Sample E Possible Course Sequence for a Certificate of High School Achievement	85
Table 11 CTS and K&E Occupational Pathways by High School Facilities	95
Table 12 Advanced Placement Courses offered in CBE High School	99

List of Figures

Figure 1 Alberta High School Diploma & Certificate of High School Achievement Requirements	7
Figure 2 An Overview of CTS Occupational Areas and K&E Occupational Courses	20
Figure 3 An Overview of Fine and Performing Arts Courses.....	37
Figure 4 An Overview of the Social Sciences Complementary Course Choices.....	58
Figure 5 Recommended English Language Arts Transfer Points	86
Figure 6 Recommended Mathematics Transfer Points.....	87
Figure 7 Recommended Science Transfer Points.....	87
Figure 8 Recommended Social Studies Transfer Points	88
Figure 9 Recommended (FLA) Course Sequences and Transfer Points	88
Figure 10 Recommended Transfer Points for K&E occupational and CTS courses	89
Figure 11 K&E Business Services -4 Sequences	89
Figure 12 K&E Cosmetology -4 Sequences	90
Figure 13 K&E Foods -4 Sequences	90
Figure 14 K&E Human Care -4 Sequences.....	90
Figure 15 K&E Art/Design and/or Art/Media -4 Sequences	91
Figure 16 K&E Fabrics -4 Sequences.....	91
Figure 17 K&E Horticulture -4 Sequences	91
Figure 18 K&E Natural Resources -4 Sequences	92
Figure 19 K&E Auto Mechanics and Services -4 Sequences.....	92
Figure 20 K&E Construction: Building -4 Sequences	92
Figure 21 K&E Construction: Metal Fabrication -4 Sequences	93
Figure 22 K&E Workplace Readiness & Practicum - Sequences	93

Get Ready...

Note | Please check the online version of the *Detailed High School Course Guide* for the most up-to-date edition. It is available on the [High School page](#) of the CBE website.

Welcome to high school with the Calgary Board of Education (CBE)

Learning in CBE High Schools

High school is about you—your interests, goals and learning. At the CBE, we are committed to your success. Teachers, student services counsellors, administrators and career practitioners, as well as your family, are all here to support you in making choices to ensure your success.

The CBE detailed high school course guide has 3 sections

GET READY | In this section:

- Reflect on your learning style, goals and interests.
- Learn about the credits, course numbering and prerequisites.
- Learn about Diploma and Certificate of Achievement requirements.
- Use the *My High School Program Planning* form to track courses you are considering.

GET SET | In this section:

- Learn about selecting set or required courses to ensure your success in school and in the future.
- Discover how English Language Learning sets you up for success when your first language is not English.

GO FOR IT | In this section:



- Explore your interests and discover new passions with:
 - Complementary Courses
 - Off-campus Education and Unique Pathways
 - Unique Settings and Delivery Options
 - Immersion and Bilingual Programs
 - Internationally Recognized Course Offering
 - Advanced Placement
 - International Baccalaureate
 - International Opportunities
 - Online learning, evening classes and summer school
- Learn about scholarships available to high school students.

Important | The Table of Contents is linked to sections of this document, so you can navigate quickly to areas of interest. Throughout the guide, there are links to relevant information on the CBE website and to related parts of the guide. Blue underlined words indicate a link. So [GET READY](#) | [GET SET](#) | [GO FOR IT](#)

GET READY |

If you attend a CBE junior high or middle school, high school counsellors will visit your school to guide your course selection.

There will also be high school open houses and information sessions that provide you with a better sense of the school you will be attending.

Planning For Your Success

High school has programs and pathways that lead toward university entrance, college and technical schools or directly to work. Most students are not absolutely sure about the paths they want to take. There is no one path that suits everyone. Planning is about finding the routes that support your learning, goals and interests. We are here to support you in making your choices confidently.

Your designated school is your community of support, where you take most of your courses, build supportive relationships with staff and students, and engage in extracurricular activities. Schools may not offer all the program and course choices in this course guide.

If there is a program or course choice you want to pursue, the principal at your designated school will help you find the best way to access it – by attending another school for part of the day or through a transfer process. Either way, your relationships with all of the adults and students in your high school will support you in personalizing your learning experiences and pursuing success.

Get Ready | Reflect

- 1 | Consider what you already know about:
 - a | your learning strengths and needs,
 - b | your interests and employment or career aspirations, and
 - c | post-secondary entrance requirements
 - [myBlueprint](#), an online planning tool, is used in a number of CBE high schools to support you in planning and connecting high school courses, post-secondary education, and career aspirations.
 - See your counsellor or career practitioner for login information.
- 2 | Talk with the people who want the best for you: parents, teachers, counsellors, career practitioners, school administrators.
- 3 | Enjoy exploring the many choices available to you as a CBE high school student.

As you learn more about yourself and discover new possibilities in high school, we will support you as you re-visit, review and revise your plans.

Flexibility as You Complete High School

Current CBE high school students may take courses at other locations including:

- 1 | The [Career and Technology Centre \(CTC\) at Lord Shaughnessy High School](#)
 - Earn credits in Career and Technology Studies (CTS) while completing equivalent Alberta Industry and Training (AIT) courses for your journeyman technical training.
- 2 | Online high school courses and online summer school at [CBe-learn](#).
- 3 | [Chinook Learning Services](#) also offers in-person summer school courses (see our [Summer School](#) section in this document for more details).

4 | [Unique Pathways & Off-campus Education](#)

- Enhance your learning through a partnership of schools, employers or post-secondary institutions that connect you with career interests and potential pathways into the workplace.
- For more information, talk to the Off-campus Coordinator or guidance counsellor at your high school.

- 5 | Work with other high schools in the CBE that may offer CTS credentialed and specialized skilled pathways and K&E occupational courses that are unavailable at your high school. All CBE high schools work together to provide a variety of complementary courses that provide you with rich possibilities to extend your learning. For more information, talk to a counsellor at your high school.

[Chinook Learning Services](#) offers in-person morning, afternoon, and evening high school courses for those who have already completed three years of high school at either the north campus (CLS at James Fowler High School or the south campus (CLS at Lord Beaverbrook High School). See page 65 for more details.



Completing High School

In Alberta, there are several ways the province recognizes high school completion:

- 1 | a High School Diploma (see the [Diploma and Certificate of High School Achievement Requirements](#)),
- 2 | a Certificate of High School Achievement (see the [Diploma and Certificate of High School Achievement Requirements](#)), and
- 3 | transitioning to a post-secondary institution or apprenticeship in Alberta.

Most students complete a High School Diploma in three years; others do so in four years. In CBE schools, counsellors, teachers, school administrators, and career practitioners support you in developing a unique learning plan that is based on your learning style, interests, goals and career aspirations.

Details about the Certificate of School Completion are available in Alberta Education's [Guide to Education](#).

Alberta also recognizes the achievement of high school students with exceptional needs and significant cognitive challenges with a **Certificate of School Completion**.

Course Numbers and Sequences

Courses are arranged in sequences and are assigned course numbers that indicate both the grade level and the type of challenges in the course.

- 1 | 1st year or Grade 10 courses start with the number 1 (for example, 10, 15, 1000) or are called Introductory in Career and Technology (CTS) courses
- 2 | 2nd year or Grade 11 courses start with the number 2 (for example, 20, 25, 2000) or are called Intermediate in CTS courses
- 3 | 3rd year or Grade 12 courses start with the number 3 (for example, 30, 35, 3000) or are called Advanced in CTS courses

Depending on your goals, sometimes the courses you take do not correspond to your grade level.

- 1 | If you are a Grade 10 student, you might register in a 20-level course in the second semester if you have successfully completed the 10-level course in the first semester.
- 2 | If you are a Grade 11 student, you might register in a 10-level course to explore another area of interest.

If there is more than one course sequence in a subject, the last digit of the course number indicates the sequence. In high school, you have choices of academic courses (such as, English 10-1, English 10-2, or English 10-4).

- 1 | Course sequences ending in -1 emphasize abstract and ambiguous challenges.
- 2 | Course sequences ending in -2, -3, and -4 do include abstract challenges, but they emphasize increasingly concrete and practical challenges.

You do **NOT** need to select all your courses from the same sequence.

- 1 | For example, depending on your strengths, needs, interests and goals, you could choose English 10-1 and Social 10-2.

There is flexibility to transfer from one sequence to another. The process begins by having a conversation with your teacher to review your work and the course outcomes.

For more detail | See [Appendix B | Part 1](#) | Course Sequences and Transfer Points as well as Figure 10 in [Appendix B | Part 2](#).

Credits

You earn credits in a course if you have a final course mark of 50% or higher.

- 1 | Credits show you have satisfactorily achieved the outcomes in a course.
- 2 | 100 credits, minimum, are needed for a High School Diploma.
- 3 | 80 credits, minimum, are needed for a High School Certificate of Achievement.
- 4 | Most students earn more than the minimum required to take advantage of the choices available and to meet post-secondary education or career requirements.
- 5 | Credits can only be earned once for any course. For example:
 - a | if you earn 45% in Science 10, you do NOT earn 5 credits. If you repeat Science 10 and earn 55%, you earn the higher mark and 5 credits,
 - b | if you earn 50% in Science 20, you earn 5 credits. If you repeat Science 20 and earn 70%, you keep the 5 credits and earn the higher mark. You do NOT earn additional credits.

Prerequisites and Co-requisites

When you earn a grade of 50% or more in a given course, you gain credits for the course and the **prerequisite** to move to the next course in a sequence (for example, English 10-1 to English 20-1).

If you do not meet the minimum final grade of 50%, current CBE high school students may choose to repeat the course at your designated high school, online (at CBe-learn), or during summer school (at CBe-learn or Chinook Learning Services).

If your grade is between 40% and 49%, you may continue on to the higher level in an alternative course sequence with a higher last digit number.

- 1 | For example, if you earn 45% in English 10-1, you may continue to English 20-2. When you successfully complete English 20-2, the retroactive credits from English 10-2, the prerequisite course, will be added, OR
- 2 | you may develop another credit recovery plan: see your school principal or assistant principal to learn more.

Important | If you have difficulty in a course, talk to your teacher right away. Use feedback and attend tutorials before retroactive credits or credit recovery is necessary.

Some courses have a **co-requisite**. This means you take a required course at the same time as the course with a co-requisite. For example:

- 1 | Math 31 requires a prerequisite or co-requisite of Math 30-1
- 2 | Advanced Acting and Touring (AAT) 25 has a pre-requisite of AAT 15 OR a co-requisite of Drama 20

Provincial Diploma Examinations

Final marks in 30-level diploma courses are a blend of the school mark and diploma exam mark—your class mark is worth 70%; the Diploma Exam is worth 30%.

Percentage weighting of diploma exams is at the discretion of Alberta Education.

If you pursue a High School Diploma in Alberta, Provincial Diploma Exams are required for the following Grade 12 courses:

- 1 | English 30-1 or English 30-2
- 2 | Social Studies 30-1 or 30-2

Additional Diploma Exams are required for students taking:

- 1 | Math 30-1 or Math 30-2
- 2 | Science 30, Biology 30, Chemistry 30, Physics 30
- 3 | French Language Arts 30-1

French Immersion students pursuing a High School Diploma in Alberta, note:

- 1 | English 30-1 or 30-2 instruction is in English; the Diploma Exam is written in English
- 2 | Social 30-1 or 30-2 instruction is in French; the Diploma Exam is available in French
- 3 | French Language Arts 30-1 instruction is in French; the Diploma Exam is in French
- 4 | Math -1 or -2 instruction is in French; Math 30-1 or 30-2 exams are available in French
- 5 | Science, Biology, Chemistry and Physics instruction is in English; the Diploma Exams are written in English at the 30-level

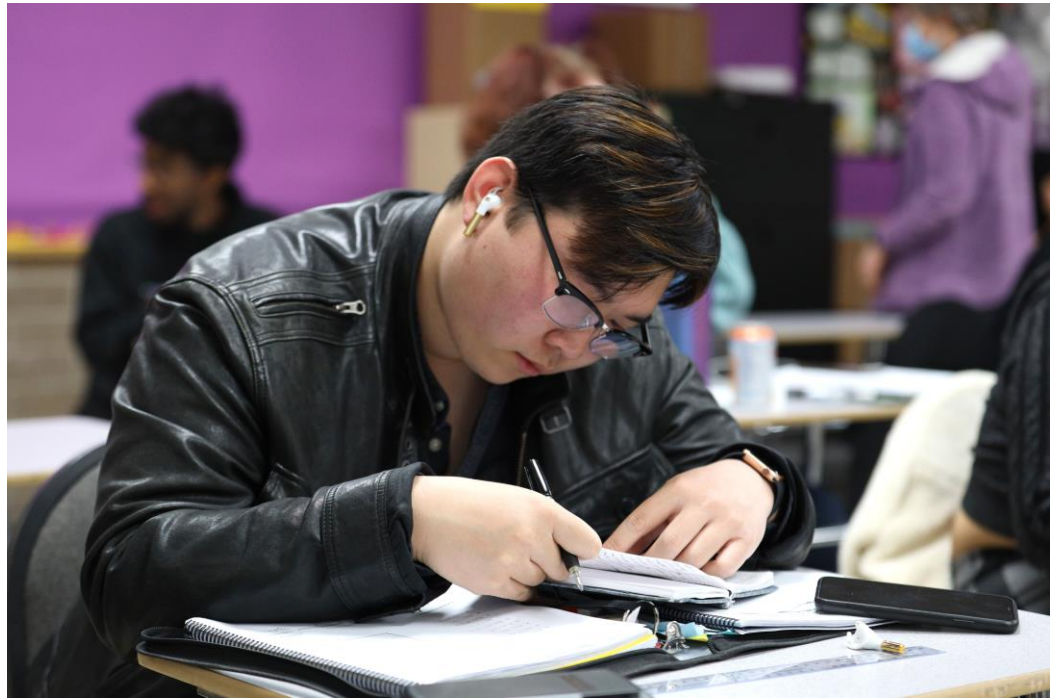

GET READY |

Learn about Diploma and Certificate of High School Achievement Requirements

Most students go beyond the minimum diploma or certificate requirements listed below because they want to take advantage of the many choices available in high school or to meet post-secondary entrance requirements. If you are undecided about the path you might take after high school, you are like many students. You will discover your talents and interests while working toward your Diploma or Certificate of High School Achievement.

Learn more | visit:
Alberta Education's [Guide to Education](#).

Note | Many high school students complete high school in three years. Some reasons for a possible fourth year include:

- taking English as a Second Language courses to develop academic language if English is not your first language
- meeting Diploma requirements after earning a Certificate of High School Achievement
- achieving a balance of academic goals, complementary course interests and extra-curricular commitments.

Talk with your counsellor and principal if a fourth year is part of your high school plan.

Starting in September 2020, non-Alberta courses completed outside of Alberta by Alberta students will not be evaluated for Alberta high school credits.

ALBERTA HIGH SCHOOL DIPLOMA MINIMUM REQUIREMENTS	100 CREDITS	ALBERTA CERTIFICATE OF HIGH SCHOOL ACHIEVEMENT MINIMUM REQUIREMENTS	80 CREDITS
<p>Earn a minimum of 100 credits. Successfully complete the following courses:</p> <ul style="list-style-type: none"> ▪ English 30-1 or 30-2*; AND ▪ Social 30-1 or 30-2*; AND ▪ Math 20-1 or 20-2 or 20-3; AND ▪ Science 20 or Science 24 or Biology 20 or Chemistry 20 or Physics 20 or Science 14 and 10; AND ▪ Physical Education (PE) 10; AND ▪ Career and Life Management (CALM); AND 		<p>Earn a minimum of 80 credits. Successfully complete the following courses:</p> <ul style="list-style-type: none"> ▪ English 20-2 or Knowledge & Employability (K&E) English 30-4; AND ▪ Math 10-3 or K&E Math 20-4; AND ▪ Science 14 or K&E Science 20-4; AND ▪ Social 10-2 or K&E Social 20-4; AND ▪ Physical Education 10; AND ▪ Career and Life Management (CALM); AND 	
<p>Earn 10 credits, in any combination:</p> <ul style="list-style-type: none"> ▪ Career and Technology Studies (CTS) courses ▪ Fine and Performing Arts courses ▪ Second Languages* courses ▪ Physical Education 20 and/or 30 ▪ Knowledge & Employability (K&E) courses ▪ Registered Apprenticeship Program (RAP) courses ▪ Locally Developed and Authorized courses in CTS, fine arts, second languages or K&E occupational courses AND 		<p>Earn 5 credits in:</p> <ul style="list-style-type: none"> ▪ 30-level K&E occupational course, or ▪ 30-level Career and Technology Studies (CTS), [Advanced level–3000 series] or ▪ 30-level Locally Developed and Authorized course with an occupational focus <p>AND</p> <p>Earn 5 credits in:</p> <ul style="list-style-type: none"> ▪ 30-level K&E Workplace Practicum course, or ▪ 30-level Work Experience course, or ▪ 30-level Green Certificate Specialization course ▪ Special Projects 30 	
<p>Earn 10 more credits, in any 30-level course (in addition to English 30-1 or 30-2 and Social 30-1 or 30-2) from:</p> <ul style="list-style-type: none"> ▪ 30-level Math, Science, Fine Arts, Second Languages, or PE ▪ Advanced Level (3000 series) CTS courses ▪ 30-level Locally Developed and Authorized courses ▪ 30-level Work Experience courses ▪ 30-level Registered Apprenticeship Program (RAP) courses ▪ 30-level K&E courses ▪ 30-level Green Certificate courses 		<p>OR instead of the 10 credits in the section immediately above</p> <p>Earn 5 credits in:</p> <ul style="list-style-type: none"> ▪ 30-level Registered Apprenticeship Program (RAP) course 	
<p>*IMPORTANT: You are encouraged to explore many options in high school; be sure to gain the prerequisites to complete the 10 credits in 30-level courses other than English and Social.</p> <p>Provincial diploma exams are required for: English 30-1 & 30-2; French Language Arts 30-1; Social 30-1 & 30-2; Math 30-1 & 30-2 (in English or French); Science 30, Biology 30, Chemistry 30, and Physics 30. Final marks in these courses are a blend of school marks and the Diploma Exam marks (your Diploma Exam is worth 30%; your school mark is worth 70%). The percentage weighting for diploma exams is at the discretion of ABED.</p>		<p>IMPORTANT:</p> <p>A Certificate of Achievement is NOT a high school diploma. K&E courses align with other courses to maximize opportunities for your success, to support your completion of high school, and to easily allow you to transfer to other courses. Such flexibility makes it possible to work toward achieving a High School Diploma. Another semester or year of high school may be part of your plan to do this.</p> <ul style="list-style-type: none"> ▪ To qualify for a Certificate of High School Achievement, you successfully complete a minimum of 1 academic Knowledge & Employability (K&E) -4 course (English, Math, Science, or Social). ▪ A Certificate of High School Achievement can be earned in 2 - 4 years. ▪ Written consent is required to register in each K&E -4 course. 	

Figure 1 | Alberta High School Diploma & Certificate of High School Achievement Requirements

GET READY | My High School Program Planning

Use this form as you read through the course descriptions in the detailed course guide and select possible courses. Blank spaces are for adding your complementary courses, and if English is not your first language, take English as Second Language (ESL) courses. List your initial choices. Make a plan; revisit your plan; change the plan as necessary.

Year 1 or Grade 10				Year 2 or Grade 11				Year 3 or Grade 12				Possible Year 4			
Course Name	Course Number	Mark	Credits	Course Name	Course Number	Mark	Credits	Course Name	Course Number	Mark	Credits	Course Name	Course Number	Mark	Credits
English	10-		5	English			5	English							
Social	10-		5	Social				Social							
Math			5	Math											
Science			5	Science											
Physical Education (PE)	10		3, 4 or 5												
				CALM			3								
Year 1 Credit Total Recommended 40 credits minimum in a 3 year plan				Year 2 Credit Total Recommended 35-38 credits minimum in a 3 year plan				Year 3 Credit Total Recommended 30-35 credits minimum in a 3 year plan				Year 4 Credit Total			

ALBERTA HIGH SCHOOL DIPLOMA MINIMUM REQUIREMENTS	
<input type="checkbox"/> English 30-1 or 30-2	<input type="checkbox"/> PE 10
<input type="checkbox"/> Social 30-1 or 30-2	<input type="checkbox"/> CALM
<input type="checkbox"/> Math 20-1 or 20-2 or 20-3	<input type="checkbox"/> 100 credits or more
<input type="checkbox"/> Science 20 or 24 or Biology 20 or Chemistry 20 or Physics 20 OR	
<input type="checkbox"/> Science 14 and Science 10	
<input type="checkbox"/> All of the above and 10 credits in any combination from: CTS, Fine Arts, Languages, PE 20 or PE 30, K&E courses, Registered Apprenticeship Program courses, or Locally Developed and Authorized Courses from any of these categories AND	
<input type="checkbox"/> 10 credits in any 30-level courses (in addition to English 30-1 or 30-2 and Social 30-1 or 30-2)	

ALBERTA CERTIFICATE OF HIGH SCHOOL ACHIEVEMENT MINIMUM REQUIREMENTS	
<input type="checkbox"/> English 20-2 or K&E English 30-4	<input type="checkbox"/> PE 10
<input type="checkbox"/> Social 10-2 or K&E Social 20-4	<input type="checkbox"/> CALM
<input type="checkbox"/> Math 10-3 or K&E Math 20-4	<input type="checkbox"/> 80 credits or more
<input type="checkbox"/> Science 14 or K&E Science 20-4	
<input type="checkbox"/> All of the above AND 5 credits in 30-level courses including: K&E occupational OR CTS courses, or Locally Developed and Authorized Courses with an occupational focus AND 5 credits in 30-level courses: including K&E Workplace Practicum, OR Work Experience, Green Certificate Specialization OR Special Projects	
<input type="checkbox"/> OR instead of the 10 credits in the section immediately above: Earn 5 credits from a 30-level Registered Apprenticeship Program (RAP) course	

Remember | 30-level courses require you to successfully complete the prerequisites.

Table 1 | My High School Program Planning

Choose Required Courses First

In high school, you choose from different courses in English Language Arts, Mathematics, Social Studies and Science. It's exciting to have choices; sometimes making decisions may seem overwhelming. Parents, counsellors, teachers, school administrators and career practitioners will support you as you make choices about your high school courses.

There is flexibility to transfer between course sequences. For details about transfer points between course sequences and a recommended process (see [Appendix B](#) | Course Sequences and Transfer Points)

Some high schools offer **blended classes** in Grades 10 and/or 11 ELA, Math, Social and/or Science to make it easier for you to change course sequences. A **blended class** combines two or more course sequences in the same classroom. As you meet the outcomes for a particular course sequence, you achieve credits for that course.

English Language Arts (ELA)

High school English Language Arts (ELA) is more than reading and writing. ELA involves:

- 1 | communicating effectively in various places for many different audiences and reasons
- 2 | selecting appropriate forms, structures, and technology for a variety of contexts
- 3 | understanding, appreciating and creating a broad range of texts (including multi-media, visual, oral, and print)

Credits: The following ELA courses are 5 credits.

Prerequisites:

- 1 | 50% minimum is required to progress to the next level in a sequence
- 2 | **Learn more** | see [Appendix B](#) for details about transfers between course sequences
- 3 | **Important** | Some schools have separate English classes in which English Language Learners develop language abilities and background cultural knowledge while learning course content, skills and strategies.

Diploma Path | -1 and -2 Course Sequences

ELA 10-1, 20-1, 30-1

- 1 | engage with Canadian and international print and multi-media texts
- 2 | emphasize literary analysis to develop critical thinking skills
- 3 | develop strong, comprehensive communication skills for university and many post-secondary programs (entrance requirements for post-secondary institutions vary; be sure to check their websites)

ELA 10-2, 20-2, 30-2

- 1 | engage with a wide range of texts and some literary analysis
- 2 | develop communication skills through practical, creative and persuasive writing and representing
- 3 | prepare for some post-secondary education programs (entrance requirements for post-secondary institutions vary; be sure to check their websites)
- 4 | **Important** | English 20-2 meets requirements Certificate of High School Achievement requirements

Certificate of High School Achievement Path | -4 Course Sequence

ELA 10-4, 20-4, 30-4

- 1 | build language skills and learn additional reading and writing strategies for success
- 2 | emphasize practical applications that support your understanding, communication, and other occupational skills
- 3 | prepare for the world of work or further training that may not involve post-secondary
- 4 | **Important** | written consent and a learning plan are required to register in each -4 Knowledge and Employability (K&E) course

One requirement for a **Diploma** is successful completion of **English 30-1** or **30-2**.

In **English 30-1** or **English 30-2**, you write a **provincial Diploma Exam**, worth 30% of your final grade. *The percentage weighting for diploma exams is at the discretion of Alberta Education.*

One requirement for a **Certificate of High School Achievement** is successful completion of a minimum of **English 20-2** or **K&E English 30-4**.

Be sure to take the prerequisites at the 10 or 20-level.

Mathematics (Math)

The main goals of mathematics education are to prepare you to:

- 1 | solve problems
- 2 | communicate and reason mathematically
- 3 | make connections between mathematics and its applications
- 4 | become mathematically literate
- 5 | appreciate and value mathematics
- 6 | make informed decisions as contributors to society

Credits: The following Math courses are 5 credits.

Prerequisites:

- 1 | 50% minimum is required to progress to the next level in a sequence
- 2 | **Learn more** | see [Appendix B](#) for details about transfers between course sequences

Minimum math requirements for a **High School Diploma** include 5 credits at the 20-level in **Math 20-1, 20-2, or 20-3.**

One requirement for a **Certificate of High School Achievement** is successful completion of **Math 10-3 or K&E Math 20-4.**

Be sure to take the prerequisite courses. In **Math 30-1 or 30-2**, you write a **provincial Diploma Exam** worth 30% of your final grade. *The percentage weighting for diploma exams is at the discretion of Alberta Education.*

Note | For French Immersion students, you take Math 10C and -1 or -2 courses in French. Math Diploma Exams are available in French.

Diploma Path | -1 and -2 Course Sequences

Math 10C

- 1 | involves topics such as measurement, powers, irrational numbers, functions and relations, and trigonometry
- 2 | focuses on algebraic skills and reasoning
- 3 | provides several choices after you successfully complete it and move to 20-level courses

Math 20-1, 30-1

- 1 | investigate the relationships between relations and functions, and engage in trigonometric topics
- 2 | develop abstract reasoning and visualization in a problem-solving environment
- 3 | prepare you for a entrance requirements for post-secondary institutions vary; be sure to check their websites

Math 20-2, 30-2

- 1 | focus on investigation into logical reasoning, relations and functions, and trigonometry
- 2 | develop problem-solving, reasoning and communication in many ways, including a self-selected research project on a topic of interest
- 3 | prepare for a post-secondary program that does not require calculus (entrance requirements for post-secondary institutions vary; be sure to check their websites)

Post-secondary Path | Requiring Calculus

Math 31

- 1 | prerequisite or co-requisite: Math 30-1
- 2 | introduces skills and topics in calculus
- 3 | investigates a variety of topics; focuses on the limit of a function and looks at the relationship between differentiation and integration

Diploma Path | -3 at the 20-level or higher Certificate of High School Achievement Path | -3 at the 10-level

Math 10-3, 20-3, 30-3

- 1 | engage in measurement skills, geometry, personal and business finances, and statistics and probability
- 2 | emphasize practical math found in day-to-day activities
- 3 | prepare you for entry into some apprenticeship programs, trades or the workforce after high school completion

Certificate of High School Achievement Path | -4 Course Sequence

Math 10-4, 20-4

- 1 | engage in measurement skills, number concepts and probability as they would be used in the workplace
- 2 | develop problem-solving and reasoning skills in a team environment
- 3 | prepare you for the workplace or further training that may not involve post-secondary education
- 4 | **Important** | written consent and a learning plan are required to register in each -4 Knowledge and Employability (K&E) course



Science

In high school science courses, you focus on interconnected ideas and principles, such as change, diversity and energy. You develop scientific knowledge through collecting, analyzing and interpreting experimental evidence. Additionally, you make connections among science, technology and society. You continue to develop your sense of wonder about the natural world.

Credits: The following Science courses are 5 credits.

Prerequisites:

- 1 | 50% minimum is required to progress to the next level in a sequence
- 2 | see [Appendix B](#) for details about transfers between course sequences

Minimum requirements for a **Diploma**, include at least one of the following:

- Science 20
- Science 24
- Biology 20
- Chemistry 20
- Physics 20, OR
- Science 14 and Science 10

In **Science 30**, **Biology 30**, **Chemistry 30**, and **Physics 30**, you write a **provincial Diploma Exam** worth 30% of your final grade. *The percentage weighting for diploma exams is at the discretion of Alberta Education.*

Minimum requirements for a **Certificate of High School Achievement** include a **Science 14 OR K&E Science 10-4 and K&E Science 20-4**.

Be sure to take the prerequisite courses.

*Entrance requirement for post-secondary institutions vary; be sure to check them online.

Note | Although the recommended transfer point from Science 24 is to Science 10, in exceptional cases, students may be placed by the principal in 20-level courses, as serves the student's best interests.

Diploma Path | 10, 20, 30 Course Sequences

Science 10

- 1 | introduces biology, chemistry, physics and global energy systems
- 2 | allows you to choose from Biology, Chemistry, Physics and/or Science at the 20-level, depending on your interests, abilities and goals

Science 20, 30

- 1 | extend the application of biological, chemical, physical and earth sciences in Science 20 and apply them to current world scenarios
- 2 | analyze interactions in biological, chemical, physical and global energy systems in Science 30
- 3 | enhance scientific literacy and prepare you for post-secondary programs*
- 4 | **Important** | Biology 20, Chemistry 20, Physics 20 or Science 20 can be used as a prerequisite to Science 30

Biology 20, 30

- 1 | engage in examining interactions of living systems with each other and their environment
- 2 | Biology 20 emphasizes energy and matter exchange
- 3 | Biology 30 focuses on adaptation and change in biological systems
- 4 | enhance scientific literacy and prepare you for post-secondary programs*

Chemistry 20, 30

- 1 | engage with the study of matter and its changes in the natural and industrial worlds
- 2 | enhance scientific literacy and prepare you for post-secondary programs*

Physics 20, 30

- 1 | engage in the exploration and analysis of the interactions between matter and energy
- 2 | understand the physics behind natural events and technology
- 3 | enhance scientific literacy and prepare you for post-secondary programs*

Diploma Path | at the 24 level

Certificate of High School Achievement Path | at the 14 level

Science 14, 24

- 1 | apply scientific knowledge and skills to everyday experiences
- 2 | are general sciences that meet the credit requirement for a high school diploma

Certificate of High School Achievement Path | -4 Science Course Sequence

Science 10-4, 20-4

- 1 | apply scientific knowledge and skills to everyday life and the workforce
- 2 | **Important** | written consent and a learning plan are required to register in each -4 Knowledge and Employability (K&E) course

Social Studies (Social)

Social Studies courses explore relationships among individuals in various societies and between societies. You examine cultural, economic, ethical, legal, and political issues that communities face. These courses focus on understanding: who am I, what kind of society do I want, and how do I and others shape our world?

Credits: The following Social Studies courses are 5 credits.

Prerequisites: 50% minimum is required to progress to the next level in a sequence

- 1 | **Learn more** | see [Appendix B](#) for details about transfers between course sequences

Sometimes schools offer a blended Social class, which combine two or more course sequences in the same classroom.

Some schools have separate Social classes in which English Language Learners develop language abilities and cultural knowledge while learning course content, skills and strategies.

One requirement for an Alberta High School **Diploma** is successful completion of **Social 30-1** or **30-2**.

In **Social 30-1** or **30-2**, you write a **provincial Diploma Exam** worth 30% of your final grade.

The percentage weighting for diploma exams is at the discretion of Alberta Education.

Note | In French Immersion, you take Social -1 or -2 in French. Social Diploma Exams are also available in French.

The minimum requirement for a **Certificate of High School Achievement** is successful completion of **Social 10-2** or **K&E Social 20-4**.

Be sure to take the prerequisites courses.

Diploma Path | -1 and -2 Course Sequences

Social 10-1, 20-1, 30-1

- 1 | examine historical and contemporary aspects and relationships among citizenship, identity and:
 - a | globalization in 10-1
 - b | nationalism in 20-1
 - c | ideologies, such as liberalism, in 30-1
 - examine relationships between citizenship and ideologies

Social 10-2, 20-2, 30-2

- explore historical and contemporary aspects and relationships among citizenship, identity and:
 - 1 | globalization in 10-2
 - 2 | nationalism in 20-2
 - 3 | ideologies, such as liberalism, in 30-2

Certificate of High School Achievement Path | -4 Course Sequence

Social 10-4, 20-4

- 1 | connect your learning to everyday experiences as you respond to key questions:
 - a | “Should we embrace globalization?” in 10-4
 - b | “Should we embrace nationalism?” in 20-4
- 2 | emphasize the importance of diversity and respect for differences to promote a sense of belonging and acceptance
- 3 | **Important** | written consent and a learning plan are required to register in each -4 Knowledge and Employability (K&E) course

Requirements for a Diploma or Certificate of High School Achievement include a minimum of:

- 3-credit course in PE 10, AND
- a 3-credit course in CALM

Physical Education (PE) supports you in acquiring skills through a variety of developmentally appropriate movement activities. You will gain experience within various physical activities assisting you in further understanding health and wellness benefits, promoting positive interactions and leading an active lifestyle.

Career and Life Management (CALM) helps you develop your ability to make well-informed decisions and choices that contribute to the well-being and respect of yourself and others.

Career & Life Management (CALM)

- 1 | **Credits:** 3 | REQUIRED COURSE
- 2 | Prerequisite: none

In CALM, you:

- 1 | apply an understanding of the emotional, psychological, intellectual, social, spiritual and physical dimensions of health
- 2 | learn responsible financial decision-making to reflect your values and goals and to demonstrate commitment to self and others
- 3 | apply strategies to manage your wellness and lifelong career development
- 4 | learn online at many high schools
- 5 | **Important** | most students take this course in Grade 11, but it can be taken in Grade 10 or 12, depending on your personalized high school program; a few schools offer CALM through their Teacher Advisory programs.

Physical Education (PE) 10

- 1 | **Credits:** 3, 4, or 5 | REQUIRED COURSE
- 2 | Prerequisite: none
- 3 | acquire skills through a variety of movement activities
- 4 | understand, experience and appreciate the health benefits and wellness that result from physical activity
- 5 | interact positively with others
- 6 | assume responsibility to lead an active lifestyle
- 7 | continue to enhance your wellness in optional PE 20 and 30 courses

Physical Education (PE) 20, 30

- 1 | **Credits:** 3, 4, or 5 each | courses of choice
- 2 | Prerequisite:
 - a | successfully complete the preceding courses for 20 and 30 levels
- 3 | engage in more activities that promote lifelong physical activity
- 4 | connect and engage with lifelong active living and wellness

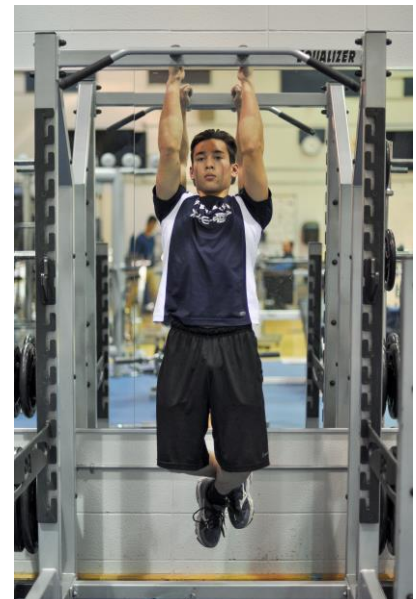

GET SET |

English Language Learning (ELL)

When your first language is not English, you learn English to talk to friends, buy things, or find your way around the city. This is **everyday English** and it usually takes one to three years to learn.

Note | As an English Language Learner, you may take more than three years to complete a High School Diploma or Certificate of High School Achievement

You also learn **academic English**—reading, writing, understanding and talking about complex ideas in English. This may take five or more years. Academic English learned in English as a Second Language (ESL) / English Language Learning (ELL)* courses contribute to success in high school, post-secondary and future employment.

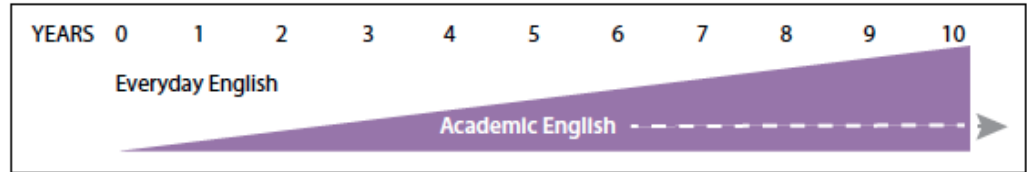

The Welcome Centre at The Education Centre registers students new to the CBE who are NOT Canadian citizens.

The Welcome Centre is open year-round for your convenience.

To book an appointment call 403-817-7789

What to expect as an English Language Learner

As an English language learner you will build a personalized course plan with the assistance of your high school to:

- 1 | determine your current and developing English language abilities in relation to the [Alberta Education ESL Proficiency Benchmarks](#)
- 2 | learn how your English language abilities improve as is evident in ongoing language assessments
- 3 | take English as a Second Languages (ESL)* courses as needed to:
 - a | support your learning of academic English and
 - b | earn credits toward your Diploma or Certificate of High School Completion
- 4 | register and succeed in high school courses based on your current and developing language strengths
- 5 | when appropriate, be connected with an adult learning centre to continue studies toward your high school Diploma or Certificate of High School Achievement
- 6 | assess credits earned for high school courses you completed outside of Alberta

*Alberta Education uses **English as a Second Language (ESL)** courses. The CBE uses **English Language Learning (ELL)** rather than ESL because many newcomers have more than two languages.

Strengthen Communicative Competence With ELL Programming

What is communicative competence?		Why is communicative competence important?		
Communicative competence is the ability to understand and use language effectively in authentic social and school environments. 	Communicating in Academic Ways	Communicative competence strengthens all of the interactions required for learning in school. 	Communicative competence supports participation in non-academic aspects of school such as sports, clubs, volunteering and social functions.	Communicative competence is required for success in life, work and continued learning.
	Using Social Rules of Language			
	Talking and Working in Groups			
	Using Background and Cultural Knowledge			
	Using Language Learning Strategies			
	Organizing Language Appropriately			
	Building Vocabulary			

Language Proficiency Levels 1 - 5

Level 1 Beginning | You will develop basic communicative English skills with a focus on listening and speaking through a variety of interactive learning experiences. You will begin to read and write texts with familiar vocabulary and sentence structures.

Level 2 Developing | You will build on communicative English language skills in listening, speaking, reading and writing. With direct instruction and support you will learn about reading and writing informational texts as you acquire a broader range of vocabulary.

Level 3 Expanding | Basic communication is becoming easier. You will continue to learn and develop your academic language skills of listening, speaking, reading and writing. These skills will need to be further developed across high school courses.

Level 4 Bridging | You will continue to develop academic language skills with a focus on reading and writing a variety of increasingly complex fiction and nonfiction texts. You will be supported in building these literacy skills as well as refining listening and speaking skills to help you reach your academic goals.

Level 5 Extending | You have acquired the social and academic language skills that help you participate across classes. You apply language strategies and continue to strengthen the academic language skills required to interact with unfamiliar texts. You are able to speak and write about a variety of academic topics while still developing more complex academic language skills.

The Alberta Education ESL Proficiency Benchmarks reflect the increase in academic language expectations as you transition to high school. It is important that you and your family prepare for language feedback that reflects this increased difficulty. Language assessment is based on current evidence in the high school context. Ongoing assessment will guide you and your teachers as you work together to further develop the academic language needed for your success in school.

The Staircase Effect of the Alberta ESL Proficiency Benchmarks



Course Names	Credits	Course Description	Language Proficiency Level				
			1	2	3	4	5
ESL 1	5	Each course further develops academic language skills by building on your current language strengths.	✓				
ESL 2	5			✓			
ESL 3	5				✓		
ESL 4	5					✓	
ESL 5	5						✓
ESL Introduction to Math 15	5	Students in this course will develop their academic language in Mathematics to successfully move into required math courses.	✓	✓			
ESL Introduction to Science 15	5	Students in this course will develop the academic language required for success in future Science courses.	✓	✓			
ESL Introduction to Canadian Studies 15	5	Students in these courses will develop academic language skills and Canadian content background knowledge necessary for success in future required Social Studies courses.	✓	✓			
ESL Introduction to Canadian Studies 25	5				✓		
ESL Expository English 15	5	Students in these courses will strengthen their understanding and application of expository (informational) texts.			✓		
ESL Expository English 25	5					✓	
Academic Achievement Through English Language Development 15	3 or 5	Students in these courses will build and extend their academic language proficiency and overall communicative competence within all aspects of literacy (listening, speaking, reading, writing, viewing, representing).*			✓		
Academic Achievement Through English Language Development 25	3 or 5					✓	
Academic Achievement Through English Language Development 35	3 or 5						✓

Table 2 | ELL / ESL Courses and Language Proficiency Levels

*These courses may be offered alongside/blended with an academic courses as an **adjunct course** to provide additional time and support for your success.

Complementary Courses and Programs of Choice

Your designated high school is the community where you:

- 1 | study your core and most of your complementary courses
- 2 | participate in extra-curricular and volunteer activities

Each high school offers a combination of unique programs and courses. CBE high schools work closely with each other to support you in accessing specialized opportunities across the CBE to find and pursue your passions.

In this section, learn more about complementary courses, programs of choice, online learning, evening classes, summer school, international opportunities, and scholarships.

Complementary courses and programs of choice include:

- 1 | Career and Technology Studies (CTS) and Knowledge and Employability (K&E) occupational courses
- 2 | Unique Pathways & Off-campus Education
- 3 | Fine and Performing Arts | Dance, Drama, Music, Visual Arts courses
 - a | The Performing and Visual Arts Program (PVA)
- 4 | Languages
 - a | French Immersion Program
 - b | Bilingual Programs and Courses | Spanish
 - c | a wide range of different Language and Culture Courses
- 5 | Complementary courses for exploring an area of a subject in detail
 - a | Aboriginal Studies, Language Arts, Interdisciplinary, Learning Competencies, Mathematics, Science, Social Sciences, Wellness
- 6 | Unique Settings and Delivery Options
 - a | Alternative High School
 - b | CBe-learn
 - c | Chinook Learning Services
 - d | Discovering Choices
 - e | Encore CBE
 - f | High Performance Athlete Development Pathway
 - g | Jack James High School
 - h | Louise Dean School
- 7 | Internationally Recognized Course Offerings
 - a | Advanced Placement (AP)
 - b | International Baccalaureate (IB) in English or French Immersion and IB Career Program
- 8 | CBE International Certificate
- 9 | Summer School
- 10 | Awards and Scholarships

You may use 10 credits from 30-level complementary courses to meet the Diploma requirements (other than English 30-1 or 30-2 and Social Studies 20-1 and 20-2).

Learn more | Visit the [Diploma and Certificate requirement information](#) in this guide to review the requirements for a Diploma or Certificate of High School Achievement.

Career and Technology Studies (CTS) and Knowledge & Employability (K&E) Occupational Choices

CTS and K&E pathways build on the Career and Technology Foundations (CTF) program of studies that allows students to explore their interests and passions as they learn about various career possibilities and occupational areas from Grades 5 – 9.

There are **5 clusters** with industry similarities:

- **BIT: Business, Administration, Finance & Information Technology**
- **HRH: Health, Recreation & Human Services**
- **MDC: Media, Design & Communication Arts**
- **NAT: Natural Resources**
- **TMT: Trades, Manufacturing & Transportation**

Note | The title of each cluster on the right is linked to the particular section of the guide so you can navigate quickly to an area of interest.

If a CTS occupational area or a K&E occupational course is not available at your school, it may be available at another CBE high school or at the Career and Technology Centre, see [Appendix C](#). Talk with your counsellor to learn how to access it.

For a list of CTS occupational areas or K&E occupational courses offered at various schools, see [Appendix C](#) | Opportunities in CTS and K&E Occupational Courses by School.

To enhance flexibility and transitions for you as a student:

- 1 | **CTS courses** are combined into **pathways** (groups of 1 credit courses where you acquire attitudes, skills and knowledge for a career based on your interests). This course guide describes each occupational CTS area as there are numerous ways CBE high schools combine the 1-credit CTS courses under each occupational area.
- 2 | CTS courses in each occupational area are offered at the:
 - a | Introductory or 1000-level
 - b | Intermediate or 2000-level
 - c | Advanced or 3000-level
 - d | Credentialed 3400-level
- 3 | Approved Locally Developed and Authorized CTS courses will have the credits listed after the course name. The levels for these are:
 - a | Introductory or 15-level
 - b | Intermediate or 25-level
 - c | Advanced or 35-level
- 4 | A **credential** is a recognition awarded by a community group or industry. Some CTS pathways support you to earn or apply for a credential.
- 5 | **Dual Credit** courses and programs allow you to earn unique high school CTS credits and post-secondary credits at the same time.
 - **Learn more** | visit [Unique Pathways & Off-campus Education](#).
- 6 | **Knowledge & Employability (K&E) occupational courses** are 5-credit courses that run parallel to CTS occupational areas.
 - K&E occupational course descriptions appear after the CTS course descriptions in each occupational area
 - for diagrams of K&E occupational sequences and transfer to CTS courses, see [Appendix B | Part 2](#) K&E Occupational Courses, starting at Figure 10
- 7 | A variety of CTS pathways and/or K&E occupational courses are available at:
 - your community high school
 - the Career and Technology Centre (CTC) at Lord Shaughnessy
 - **Learn more** | visit the [CTC](#) website
 - [Unique Pathways & Off-campus Education](#)
 - Dual Credit, Exploratory and Internships
 - Work Experience and RAP
 - Other high schools in the CBE
 - **Learn more** | see [Appendix C](#) | CTS and K&E Occupational Courses by School or talk to a counsellor at your high school

GO FOR IT |

CTS and K&E Occupational courses build on the Career and Technologies Foundations (CTF) Programs of Study from Grades 5-9. CTS courses are offered at the introductory, intermediate, advanced and/or credentialed levels. Alberta Education has identified 5 course clusters with industry similarities, which are indicated to the right. Below each cluster are lists of occupational areas.

CTS credits may be earned through Dual Credit or Exploratory programming. See [Unique Pathways](#) for information.

Learn more | [For detailed descriptions and locations offered by school](#)

If an occupational area is not available at your high school, it may be available at another high school nearby. Talk with your counsellor to explore how to access it.

The Career and Technology Centre (CTC), part of the Central Memorial High School campus, is open to all CBE high School students for selected specialized complementary courses.

Learn more | Visit the [CTC website](#)

***High Performance Athlete Development (HPAD) Pathway** is based at Bowness High School for student athletes in Grades 10 to 12 who want to participate in an elite performance program while pursuing academic goals within a healthy high school culture. Students will engage in activities and high performance sports that provide a theoretical, practical, and experiential platform for learning.

Note | There is a supplemental fee attached to the Pathway.

Learn more | Visit the [Bowness High School](#) website

Jack James High School is open to all CBE high school students for a personalized pathways approach to learning, offering a variety of CTS courses and K&E Occupational Courses.

Learn more | Visit the [Jack James website](#)

An Overview of CTS and K&E Occupational Courses

Go For It | Complementary Courses and Programs of Choice

Career and Technology Studies (CTS) and Knowledge and Employability (K&E) Occupational Courses

Trades, Manufacturing & Transportation (TMT)

- Aviation
- Electro-Technologies
- Fabrication
- Mechanics
 - Auto Body Services
 - Automotive Services

K&E TMT

- Autobody
- Auto Mechanics
 - Auto Mechanics
 - Auto Services
- Construction: Building
 - Woodworking & Cabinetry
 - Woodframe Construction
- Construction: Metal Fabrication
 - Metal Fabrication
 - Construction Systems

Business, Administration, Finance & Information Technology (BIT)

- Computing Sciences
- Enterprise and Innovation
- Financial Management
- Information Processing
- Management & Marketing
- Networking

K&E BIT

- Business Services
- Sales and Service
- Logistics
- Office Services

Natural Resources (NAT)

- Agriculture
- Environmental Stewardship
- Forestry
- Primary Resources
- Wildlife

K&E NAT

- Horticulture
 - Greenhouse & Nursery
 - Landscaping
- Natural Resources
 - Agriculture
 - Forestry
 - Oil & Gas

Innovation Technology Courses

Innovation Technology courses focus on a variety of STEM concepts. Common names for Innovation technology courses include Design Innovation, Robotics, Engineering Studies, etc. Check individual high school websites to determine the Innovation Technology courses offered at each location.



Media, Design & Communication Arts (MDC)

- Communication Technology
- Design Studies
- Fashion Studies

K&E MDC

- Art, Design & Communication
 - Art/Design
 - Art/Media Communication
- Fabrics
 - Fashion Textiles
 - Industrial Textiles

Health, Recreation & Human Services (HRH)

- Community Care Services
- Cosmetology
- Esthetics
- Foods
- Health Care Services
- Human and Social Services
- Legal Studies
- Recreation Leadership
- Tourism

K&E HRH

- Criminal Justice Studies
- HealthCare Aid
- Cosmetology
 - Cosmetology
 - Esthetics
- Human Care
 - Child Care
 - Home Care
- Foods
 - Commerical Cooking
 - Food Preparation

Athletics

Sports Medicine, Sports Performance, and the High Performance Athlete Development Pathway (HPAD)* include course work from several HRH occupational pathways.

Figure 2 | An Overview of CTS Occupational Areas and K&E Occupational Courses

Remember:

- Specialized Unique Pathways & Off-campus Education opportunities are added throughout the school year.
Learn more | visit [Unique Pathways & Off-campus Education](#) on the CBE website
- Written consent is required to register in each K&E course

If a CTS occupational area or a K&E occupational course is not available at your school, it may be available at another CBE high school or at the Career and Technology Centre, see [Appendix C](#). Talk with your counsellor to learn how to access it.

For a list of CTS occupational areas or K&E occupational courses offered at various schools, see [Appendix C](#) | Opportunities in CTS and K&E Occupational Courses by School.

Business, Administration, Finance & Information Technology (BIT)

The **BIT** cluster focuses on management, marketing and use of electronic technologies to access, use and manipulate information within your personal, family, workplace, community and global contexts. The occupational areas in **BIT** include:

Computing Science

- 1 | use mathematical concepts to explore, design, build and test computer programs using a variety of languages which may include Java, C++, C#, Alice and/or Visual Basic
- 2 | **AP Computer Science A** available at select schools
- 3 | **Credentials available:** Alberta universities accept 5 credits in Computer Science Advanced as a 30-level science requirement

Enterprise and Innovation

- 1 | draw upon your entrepreneurial spirit and learn how to create, analyze, finance, market, create and manage a business venture

Financial Management

- 1 | learn about personal financial literacy and general accounting principles
- 2 | explore small businesses and venture planning

Information Processing

- 1 | become proficient with the use of Office applications
- 2 | **K&E Courses available:** see Business Services and Office Services -4 at the end of the **BIT** section

Management and Marketing

- 1 | explore basic management concepts and describe retail merchandising strategies of value to the retail employee, manager and/or owner
- 2 | learn about e-commerce, marketing and communication strategies
- 3 | **K&E Courses available:** see Business Services -4 and Sales and Services -4 at the end of the **BIT** section
- 4 | Dual Credit opportunities available
 - a | **Learn more** | visit [Unique Pathways & Off-campus Education](#)

Networking

- 1 | learn about Information Technology (IT) and networking with a focus on the design and maintenance of computer hardware and networks
- 2 | **Credentials available:** CompuTIA+ and CompuTIA Network+ and Focus on Information Technology (FIT)

GO FOR IT |

K&E
Occupational Courses |
BIT

Knowledge & Employability (K&E) Business Services -4

- 1 | **Credits:** 5 each
- 2 | **Prerequisites:**
 - a | see [Appendix B | Part 2](#), Figure 11 for a diagram of Business Services pathways and prerequisites
 - b | none for Business Services 10-4
 - c | successfully complete Business Services 10-4 for 20 levels of Sales and Service, Office Services and/or Logistics
 - d | successfully complete 20-4 for 30-4 levels in each course sequence
- 3 | **Business Services 10-4** develops occupational knowledge and skills for entry-level positions in office services, sales and service and logistics (supply chain)
- 4 | **Sales and Service 20-4 and 30-4** focus on service in retail and hospitality
- 5 | **Logistics 20-4 and 30-4** focuses on delivery and transportation of goods
- 6 | **Office Services 20-4 and 30-4** focuses on office operations and business strategies
- 7 | take as many courses as possible at the 20 and 30 levels for employability
- 8 | take a related Workplace Practicum or Work Experience course for additional practical experience
- 9 | **Important | Written consent** and a learning plan are required to register in each -4 Knowledge and Employability (K&E) course.



GO FOR IT |

CTS Occupational Areas

If a CTS occupational area or K&E occupational course is not available at your school, it may be available at another CBE high school or at the Career and Technology Centre, see [Appendix C](#). Talk with your counsellor to learn how to access it.

For a list of CTS occupational areas or K&E occupational courses offered at various schools, see [Appendix C](#) | Opportunities in CTS and K&E Occupational Courses by School.

Health, Recreation & Human Services (HRH)

The **HRH** cluster focuses on a vast array of challenging and rewarding careers in health care, community supports, recreation, cosmetology, food services, tourism and law.

Community Care Services

- 1 | understand the needs and care of diverse members of a community
- 2 | experience volunteering and develop skills to provide services in community-based organizations in a variety of settings
- 3 | **Credentials available:** Level 1 - Early Learning and Child Care Assistant
- 4 | **K&E courses available:** see Human Care -4, Home Care -4, and Child Care -4 at the end of the **HRH** section

Cosmetology

- 1 | learn about basic hair, skin and nail care services and gain knowledge and practical experience while working on mannequins and classmates
- 2 | practice advanced techniques and gain the confidence needed to work with clients and gain client service experience
- 3 | perform other services of a cosmetologist, which may include esthetic services like manicures, make-up application, facials, or facial hair removal.
- 4 | **Credentials available:** Hairstylist Apprenticeship
- 5 | **K&E courses available:** see Cosmetology and Esthetics -4 at the end of the **HRH** section

Foods

- 1 | learn about food production, food preparation and meal planning
- 2 | understand nutrition and healthy food choices, food costs and economics, and safe food handling techniques
- 3 | participate in cooking, baking and food presentation for personal enjoyment and for the food service industry
- 4 | schools may offer a culinary arts program in a commercial kitchen setting and/or a personal food program to learn domestic food preparation and cooking skills
- 5 | **Credentials available:** Cook Apprenticeship; Baker Apprenticeship
- 6 | **K&E courses available:** see Foods -4, Food Preparation and Service -4, and Commercial Cooking-4 the end of the **HRH** section

Health Care Services

- 1 | learn about the human body by examining anatomy and the function of body systems
- 2 | understand the resources to support health and wellness of individuals in the health care context
- 3 | develop skills in first aid, CPR and safety necessary for careers in emergency response and medical technology
- 4 | **Learn more** | visit the [Unique Pathways & Off-campus Education](#) website to see Dual Credit and Exploratory program opportunities in this area

Human and Social Services

- 1 | learn about human development, family support, as well as professional standards and ethics
- 2 | understand perspectives on relationships and develop effective leadership and mentorship skills
- 3 | **K&E courses available:** see Human Care -4, Child Care -4 and Home Care -4 at the end of **HRH** section

Leadership

- 1 | includes coursework from a variety of occupational pathways including: Community Care Services, Health Care Services, and Human and Social Services

GO FOR IT |

CTS Occupational Areas | HRH

If a CTS occupational area or K&E occupational course is not available at your school, it may be available at another CBE high school or at the Career and Technology Centre, see [Appendix C](#). Talk with your counsellor to learn how to access it.

For a list of CTS occupational areas or K&E occupational courses offered at various schools, see [Appendix C](#) | Opportunities in CTS and K&E Occupational Courses by School.

Legal Studies

- 1 | learn about:
 - a | workplace and consumer law
 - b | focus on basic rights and responsibilities and legal issues relating to personal relationships
- 2 | explore the legal relationship between government and the citizen with an emphasis on property law, dispute resolution, small business law, controversy and change, and criminal law

Recreation Leadership

- 1 | develop skills useful for sports performance training, coaching, leading fitness and recreation activities
- 2 | understand sports injury and practice skills used in sports injury management
- 3 | one of the most frequently offered pathways in this occupational area is **Sports Medicine**

Sports Medicine, Medical Studies, Sports Performance

- 1 | include coursework from a variety of occupational pathways including: Community Care Services, Health Care Services, Human and Social Services, and Recreational Leadership

Tourism

- 1 | explore the impact of tourism in Alberta and around the world
- 2 | develop knowledge and skills required in various aspects of the hospitality and tourism industry
- 3 | develop management, organization and communication skills related to leadership roles in tourism



GO FOR IT |

K&E Occupational Courses | HRH

Use the link to [Appendix B | Part 2](#) | Knowledge and Employability Occupational Course Sequences to view diagrams of course sequences on this page.

K&E Cosmetology -4

- 1 | **Credits:** 5 each
- 2 | **Prerequisites:**
 - a | none for Cosmetology 10-4
 - b | successfully complete Cosmetology 10-4 for 20-4 levels of Cosmetology and/or Esthetics
 - c | successfully complete 20-4 course for 30-4 levels in each course sequence
- 3 | **Cosmetology 10-4**
 - a | learn about safety and knowledge of tools (extend at higher course levels)
 - b | develop knowledge and skills in hair dressing, hair cutting and skin care
- 4 | **Cosmetology 20-4 and 30-4** focus on hair cutting, dressing and care
- 5 | **Esthetics 20-4 and 30-4** develop knowledge and skills in make-up and skin care
- 6 | take both courses, if possible, at the 20 and 30 levels to enhance employability
- 7 | take a related Workplace Practicum or Work Experience course for additional practical experience
- 8 | **Important** | Written consent and a learning plan are required to register in each K&E course.

K&E Foods -4

- 1 | **Credits:** 5 each
- 2 | **Prerequisites:**
 - a | none for Foods 10-4
 - b | successfully complete Foods 10-4 for 20-4 levels of Food Preparation and Service and/or Commercial Cooking
 - c | successfully complete the 20-4 course for the 30-4 level in each course sequence
- 3 | **Foods 10-4**
 - a | learn and use safety standards and industry equipment (extend at higher course levels)
 - b | learn about the food service industry and learn to cook
- 4 | **Food Preparation and Service 20-4 and 30-4** focus on basic food preparation and customer service
- 5 | **Commercial Cooking 20-4 and 30-4** develop knowledge and skills in banquet and reception food preparation and service
- 6 | take both courses, if possible, at the 20 and 30 levels to enhance employability
- 7 | take a related Workplace Practicum or Work Experience for additional practical experience
- 8 | **Important** | Written consent and a learning plan are required to register in each K&E course.

K&E Human Care -4

- 1 | **Credits:** 5 each
- 2 | **Prerequisites:**
 - a | none for Human Care 10-4
 - b | successfully complete Human Care 10-4 for 20-4 levels of Home Care and/or Child Care
 - c | successfully complete the 20-4 courses for the 30-4 course in the same sequence
- 3 | **Human Care 10-4**
 - a | learn and use safety standards and equipment (extend at higher course levels)
 - b | learn the basics of child care and home care for the elderly
- 4 | **Child Care 20-4 and 30-4** focus on the care and development of children
- 5 | **Home Care 20-4 and 30-4** focus on providing care services to the elderly
- 6 | take both courses, if possible at the 20 and 30 levels to enhance employability
- 7 | take a related Workplace Practicum or Work Experience for additional practical experience
- 8 | **Important** | Written consent and a learning plan are required to register in each K&E course.

Note | Jack James High School has a daycare for the local community in the school. In the child care courses you

- learn safe and age-appropriate activities, appropriate child management techniques, and nutritional needs of children
- make a commitment for one semester (all classes operate from 8:45 –10:45 a.m.)

Learn More | visit the [Jack James High School](#) website.

GO FOR IT |

CTS Occupational Areas

If a CTS occupational area or K&E occupational course is not available at your school, it may be available at another CBE high school or at the Career and Technology Centre, see [Appendix C](#). Talk with your counsellor to learn how to access it.

For a list of CTS occupational areas or K&E occupational courses offered at various schools, see [Appendix C](#) | Opportunities in CTS and K&E Occupational Courses by School.

Media, Design & Communication Arts (MDC)

The **MDC** cluster is designed to provide you with the flexibility to adapt to various situations relating to design, communication and aesthetics. This cluster includes courses related to art and culture, such as the performing arts, film and video, broadcasting, journalism, writing, creative design, and fashion.

Important | Check with your school to learn which area(s) of specialization are offered.

Communication Technology

- 1 | discover and develop skills using various forms of media, including animation, print, photography and audio/visual
- 2 | includes specializations in web design, animation, photography, or video and film
- 3 | **K&E occupational courses available:** see Art/Design and Art/Media Communications -4 at the end of the **MDC** section

Design Studies

- 1 | learn about the creative process from conception through to development in architecture, industrial design, engineering, interior design and landscaping
- 2 | demonstrate your design abilities with programs such as AutoCad, Fusion 360, Sketch Up, 3D Studio Max, Revit and/or Maya
- 3 | **K&E occupational courses available:** see Art/Design-4 at the end of the **MDC** section

Fashion Studies

- 1 | design, manufacture, and market clothing and other textile products, as well as study the history, sociology and economics of clothing and textile arts
- 2 | **K&E occupational courses available:** see Fabrics -4, Fashion Textiles -4, and Industrial Textiles -4 at the end of the **MDC** section



GO FOR IT |

K&E Occupational Courses | MDC

Use the link to [Appendix B | Part 2](#) | Knowledge and Employability Occupational Course Sequences to view diagrams of course sequences on this page.

K&E Art/Design -4

- 1 | **Credits:** 5 each
- 2 | **Prerequisites:**
 - a | none for Art/Design 10-4
 - b | successful completion of the preceding courses for 20 and 30-level courses
- 3 | **Art/Design 10-4, 20-3, 30-4** focus on learning elements and process of design by creating various 2-D and 3-D projects, graphics, blueprints and clothing
- 4 | take a related Workplace Practicum or Work Experience for additional practical experience
- 5 | **Important** | Written consent and a learning plan are required to register in each K&E course.

K&E Art/Media Communications -4

- 1 | **Credits:** 5 each
- 2 | **Prerequisites:**
 - a | none for Art/Media Communications 10-4
 - b | successful completion of the preceding courses for 20 and 30-level courses
- 3 | **Art/Media Communications 10-4, 20-4, 30-4** focus on the design elements and processes through the exploration of photography, videography, graphic arts, promotional products, multimedia projects, 3-D models and animation
- 4 | take a related Workplace Practicum or Work Experience for additional practical experience
- 5 | **Important** | Written consent and a learning plan are required to register in each K&E course.

K&E Fabrics and Textiles -4

- 1 | **Credits:** 5 each
- 2 | **Prerequisites:**
 - a | none for Fabrics 10-4
 - b | successfully complete Fabrics 10-4 for 20-4 levels of Industrial Textiles and/or Fashion Textiles
 - c | successfully complete 20-4 level for 30-4 level courses in the same course sequence
- 3 | **Fabrics 10-4**
 - a | identify procedures used for the care and maintenance of fabrics and articles of clothing
 - b | develop basic knowledge and skills to safely and properly use the tools, equipment and materials used in clothing construction (extend at higher course levels)
- 4 | **Fashion Textiles 20-4 and 30-4** develop knowledge and skills in pattern selection and garment construction
- 5 | **Industrial Textiles 20-4 and 30-4** focus on laundering, repairing and constructing various fabrics for a variety of projects in industry and the home
- 6 | take as many courses as possible at the 20 and 30 levels to enhance employability
- 7 | take a related Workplace Practicum or Work Experience for additional practical experience
- 8 | **Important** | Written consent and a learning plan are required to register in each K&E course.

GO FOR IT |

CTS Occupational Areas

If a CTS occupational area or K&E occupational course is not available at your school, it may be available at another CBE high school or at the Career and Technology Centre, see [Appendix C](#). Talk with your counsellor to learn how to access it.

For a list of CTS occupational areas or K&E occupational courses offered at various schools, see [Appendix C](#) | Opportunities in CTS and K&E Occupational Courses by School.

Natural Resources (NAT)

The **Natural Resources** cluster focuses on conservation and the sustainable use of natural resources. In this cluster, you develop the motivation and commitment to work individually and collectively as a private citizen and member of the workforce towards the conservation and responsible use of air, energy, forests, land, minerals, water and wildlife.

Agriculture

- 1 | learn about the 'how' and 'why' of producing agricultural and/or horticultural products
- 2 | understand how to support development and efficient use of our natural resources
- 3 | **K&E courses available:** see Natural Resources-4, and Agriculture-4 at the end of **NAT** cluster
- 4 | Green Certificate and other Dual Credit opportunities available
a | **Learn more** | visit [Unique Pathways & Off-campus Education](#)

Environmental Stewardship

- 1 | learn about conservation and management of our environment
- 2 | explore and propose actions to foster sustainable development of our resources
- 3 | dual Credit opportunities available
a | **Learn more** | visit [Unique Pathways & Off-campus Education](#)

Forestry

- 1 | learn about forests as a resource and how to maintain their sustainability
- 2 | study the impact of forests on our society and our impact on forests
- 3 | **K&E courses available:** see Natural Resources-4 and Forestry-4 at the end of the **NAT** section

Primary Resources

- 1 | learn about Alberta's hydrocarbon [oil and gas] and mineral resources and their importance to society
- 2 | study techniques and technologies related to Alberta's oil, gas and mineral industries
- 3 | **K&E courses available:** see Natural Resources -4 and Oil and Gas -4 at the end of **NAT** section

Wildlife

- 1 | learn about our relationship with the natural environment
- 2 | consider the impact of our pursuits on species and ecosystems



GO FOR IT |

K&E Occupational Courses | NAT

Use the link to [Appendix B | Part 2](#) | Knowledge and Employability Occupational Course Sequences to view diagrams of course sequences on this page.

K&E Horticulture -4

- 1 | **Credits:** 5 each
- 2 | **Prerequisites:**
 - a | none for Horticulture 10-4
 - b | successfully complete Horticulture 10-4 for 20-4 levels of Greenhouse & Nursery or Landscaping & Maintenance courses
 - c | successfully complete the 20-4 course to take the 30-4 course in the same sequence
- 3 | **Horticulture 10-4**
 - a | develops basic knowledge of and skills to safely and properly use the tools, equipment and materials (extend in higher course levels)
 - b | develops knowledge, skills and effort needed to perform tasks related to soil, plants and the planting process, or needed to grow and maintain turf or grasses
- 4 | **Horticulture: Greenhouse and Nursery 20-4 and 30-4** develop knowledge of and skills with soil and plants through planting and caring for various plants
- 5 | **Horticulture: Landscaping & Maintenance 20-4 and 30-4** develop ability to design, produce, and maintain a landscaped area
- 6 | take both courses at the 20 and 30 levels to increase employability
- 7 | take a related Workplace Practicum or Work Experience for additional practical experience
- 8 | **Important** | Written consent and a learning plan are required to register in each K&E course.

K&E Natural Resources -4

- 1 | **Credits:** 5 each
- 2 | **Prerequisite:**
 - a | none for Natural Resources 10-4
 - b | successfully complete Natural Resources 10-4 for 20-4 levels of Agriculture, Forestry and/or Oil and Gas
 - c | successfully complete the 20-4 course to take the 30-4 course in the same sequence
- 3 | **Natural Resources 10-4**
 - a | develops basic skills to safely and properly use the tools, equipment and materials
 - b | focuses on harvesting and processing practices for the oil and gas, forestry and agriculture industries
- 4 | **Agriculture 20-4 and 30-4** provides practical experiences with land and crop development and livestock care and feeding
- 5 | **Forestry 20-4 and 30-4** focuses on mapping, harvesting and processing equipment and practices; forest fire management; environmentalism and field preparation
- 6 | **Oil and Gas 20-4 and 30-4** develops skills for processing equipment and practices, energy source identification, resource management and field preparation
- 7 | take a related Workplace Practicum or Work Experience for additional practical experience
- 8 | **Important** | Written consent and a learning plan are required to register in each K&E course.

If a CTS occupational area or K&E occupational course is not available at your school, it may be available at another CBE high school or at the Career and Technology Centre, see [Appendix C](#). Talk with your counsellor to learn how to access it.

For a list of CTS occupational areas or K&E occupational courses offered at various schools, see [Appendix C](#). | Opportunities in CTS and K&E Occupational Courses by School.

Trades, Manufacturing & Transportation (TMT)

In the **TMT** cluster, you focus on skills and knowledge related to the design, construction, fabrication and maintenance of a product. This cluster includes courses that relate to manufacturing, processing, utilities, construction, mechanics, fabrication, trades supervision, trades contracting, logistics, transportation and heavy equipment.

Aviation

- 1 | learn about the design, maintenance, production, operation and use of an aircraft
- 2 | gain an understanding of practical aspects of aeronautics
- 3 | understand and appreciate the potential of aviation and space to help humans and to improve our daily lives and our growing society
- 4 | gain an understanding of air law and procedures, meteorology, navigation and communication
- 5 | explore more than one occupational area in **TMT** and locally developed courses, including Aeronautical Design 25 (5 credits) and Aviation 35 (3 credits)

Construction

- 1 | learn about skills, techniques, safe tool and equipment operating practices and procedures for use in cabinet making and residential construction
- 2 | read drawings, integrate skills and develop confidence in current construction methods while working on construction projects
- 3 | **K&E courses available:** see Construction: Building -4, Construction Systems -4, and Woodworking and Cabinetry -4 at the end of the **TMT** section
- 4 | Dual Credit and Exploratory opportunities available
 - a | **Learn more** | visit [Unique Pathways & Off-campus Education](#)

Electro-Technologies

- 1 | learn about the design, development, testing, production, service, repair and operation of electrical and electronic equipment and systems
- 2 | learn to provide technical support and services of electrical and electronic equipment
- 3 | learn to use software for programmed control of robotic systems
- 4 | control robotic movements, use sensors and develop simulation applications

Fabrication (Welding)

- 1 | understand theory and practical aspects of the metal trades
- 2 | learn basic skills, safety, material handling and safe handling of tools and equipment used in metallurgy
- 3 | learn blueprint reading, various welding techniques, thermal cutting, sheet fabrication, forging and foundry skills, moulding, milling, turning and pipefitting
- 4 | **Credentials available:** Welder Period 1 Apprentice
- 5 | **K&E courses available:** see Construction: Metal Fabrication -4 and Construction Systems -4 at the end of the **TMT** section
- 6 | Dual Credit and Exploratory opportunities available
 - a | **Learn more** | visit [Unique Pathways & Off-campus Education](#)

GO FOR IT |

CTS Occupational Courses | TMT

If a CTS occupational area or K&E occupational course is not available at your school, it may be available at another CBE high school or at the Career and Technology Centre, see [Appendix C](#). Talk with your counsellor to learn how to access it.

For a list of CTS occupational areas or K&E occupational courses offered at various schools, see [Appendix C](#) | Opportunities in CTS and K&E Occupational Courses by School.

Use the link to [Appendix B | Part 2](#) | Knowledge and Employability Occupational Course Sequences to view diagrams of course sequences on this page.

Auto Body Services

- 1 | learn about auto body repair products, applications, the use of hand/air tools and their application in the auto body and refinishing industry
- 2 | gain experience in methods, procedures, and machine tool technology while working on automotive components and vehicles
- 3 | **Credentials available:** Auto Body Technician Apprenticeship
- 4 | **K&E courses available:** see Auto Body Repair 15, 25, 35 at the end of the **TMT** section

Automotive Services Technician (Mechanics)

- 1 | learn about the modern automobile, automotive technology and the related systems
- 2 | develop safe and appropriate shop procedures and practices while learning to inspect, diagnose, repair and service mechanical, electrical and electronic systems, and components of cars and light and commercial transport trucks
- 3 | **Credentials available:** Auto Service Technician Apprenticeship
- 4 | **K&E courses available:** see Auto Mechanics and Services -4 at the end of the **TMT** section

K&E Auto Body Repair 15, 25, 35

- 1 | **Credits:** 5 each
- 2 | **Prerequisites:**
 - a | none for 15-level
 - b | successfully complete earlier levels for 25 and 35 levels
- 3 | learn introductory, organizational, and math skills for the autobody industry
- 4 | learn about auto body repair products, applications, the use of hand/air tools and their application in the auto body and refinishing industry
- 5 | gain experience in methods, procedures, and machine tool technology while working on automotive components and vehicles
- 6 | take a related Workplace Practicum or Work Experience course for additional practical experience
- 7 | **Important** | Written consent and a learning plan are required to register in each K&E course.

K&E Auto Mechanics and Services -4

- 1 | **Credits:** 5 each
- 2 | **Prerequisites:**
 - a | none for Auto Mechanics 10-4
 - b | successfully complete Auto Mechanics 10-4 for both 20-4 Auto Mechanics and/or Auto Services courses
 - c | successfully complete the 20-level course in each sequence for the 30-level course in the same sequence
- 3 | **Auto Mechanics 10-4** develops the basics of Auto Mechanics and Auto Services
- 4 | **Auto Mechanics 20-4 and 30-4** focus on steering, chassis, and suspension repair
- 5 | **Auto Services 20-4 and 30-4** focus on lubrication, oil changes, and other regular maintenance
- 6 | take both pathways to enhance employability in Auto Mechanics and Services
- 7 | take a related Workplace Practicum or Work Experience course for additional practical experience
- 8 | **Important** | Written consent and a learning plan are required to register in each K&E course.

GO FOR IT |

K&E
Occupational
Courses | TMT

CTS |
Multi-cluster
Occupational Areas
and Pathways

If a CTS occupational area or K&E occupational course is not available at your school, it may be available at another CBE high school or at the Career and Technology Centre, see [Appendix C](#). Talk with your counsellor to learn how to access it.

For a list of CTS occupational areas or K&E occupational courses offered at various schools, see [Appendix C](#) | Opportunities in CTS and K&E Occupational Courses by School.

K&E Construction: Building -4

- 1 | **Credits:** 5 each
- 2 | **Prerequisites:**
 - a | none for Construction: Building 10-4
 - b | successfully complete Construction: Building 10-4 for both 20-4 levels of Woodworking & Cabinetry and/or Wood Frame Construction
 - c | successful completion of the 20-level course in each sequence is a prerequisite for the 30-level course in that sequence
- 3 | **Construction: Building 10-4** develops the basics of Woodworking, Cabinetry, and Wood Frame Construction
- 4 | **Construction Systems 20-4 and 30-4** develops knowledge and skills to manufacture support frames and walls for buildings
- 5 | **Woodworking and Cabinetry 20-4 and 30-4** focus on manufacturing wood products
- 6 | take both Construction courses, if possible, at the 20 and 30 levels to increase employability
- 7 | take a related Workplace Practicum or Work Experience course for additional practical experience
- 8 | **Important** | Written consent and a learning plan are required to register in each K&E course.

K&E Construction: Metal Fabrication -4

- 1 | **Credits:** 5 each
- 2 | **Prerequisites:** see [Appendix B | Part 2](#) for a diagram of Metal Fabrication pathways
 - a | none for Construction: Metal Fabrication 10-4
 - b | successfully complete Construction: Metal Fabrication 10-4 for both 20 levels of Construction Systems and Metal Fabrication
 - c | successfully complete the 20-level course in each to take the 30-level course in the same sequence
- 3 | **Construction: Metal Fabrication 10-4, 20-4 and 30-4** develops basic knowledge and skills about how to join and finish metals
- 4 | **Construction Systems 20-4 and 30-4** focus on specific knowledge related to the heating, ventilation and air conditioning (HVAC), electrical, masonry and plumbing trades
- 5 | take both courses if possible at the 20 and 30 levels to enhance employability
- 6 | take a related Workplace Practicum or Work Experience course for additional practical experience
- 7 | **Important** | Written consent and a learning plan are required to register in each K&E course.

Innovation Technology Courses

Innovation Technology courses focus on a variety of STEM concepts. These classes expose students to a broad range of knowledge and technical skills using modern and emerging technologies such as 3D-printers, laser cutters, microcontrollers, electronics, robotics, and more.

The course name, specific skills and concepts, credit structure, equipment and technology utilized in innovation technology courses may vary from school to school. Common names for Innovation technology courses include Design Innovation, Robotics, Engineering Studies, etc.

Check individual high school websites to determine the Innovation Technology courses offered at each location.

Building Trades 25, 35

- 1 | **Credits:** 5 each
- 2 | **Prerequisites:**
 - a | successfully complete levels 25 to enrol in 35
- 3 | learn about electrical and plumbing systems in a residential home

Engineering Studies

- 1 | **Credits:** 3 to 5 each
- 2 | **Prerequisites:**
- 3 | investigate variety of fundamental engineering concepts that may include: CAD design, automation, robotics, electronics, coding, electrical, pneumatic and mechanical control systems
- 4 | design, build, test analyze a variety of engineering focus projects
- 5 | focus and delivery method may be unique to each high school

Robotics

- 1 | **Credits:** 5 each
- 2 | **Prerequisites:**
 - a | none for 15
 - b | successfully complete preceding levels for 25 and 35
- 3 | learn to design, construct and control robots and robotic systems.
- 4 | may learn CAD Design, electrical, mechanical, structural systems as well as programming
- 5 | focus, delivery method and robotic platform may be unique to each high school

Off-campus Education

- During the regular school year (September –June) talk to your home high school's Off-campus coordinator for more information and eligibility. If you aren't sure who this is, check with your guidance counsellor.
- If you are looking for summer program offerings connect to Chinook Learning (Hot link Chinooks website)

Workplace Safety Systems (HCS 3000)

- 1 | **Credit:** 1
- 2 | **Prerequisite:** none
- 3 | **Required course to register in any Work Experience course, including Exploratory Programs and Internships**
- 4 | gain the attitudes, knowledge and skills related to workplace health and safety and examine relevant legislation required in the workplace

Note | For any Off-campus Education opportunities, HCS 3000, a workplace safety course, must be completed first.

Workplace Safety Practices (HCS 3010)

- 1 | **Recommended as a prerequisite** if enrolling in the Register Apprenticeship Program (RAP)
- 2 | May be required as a pre-requisite for some Exploratory programs and Internships
- 3 | explore workplace safety principles and practices, and apply these principles and practices to a variety of contexts

Work Experience 15, 25, 35

- 1 | **Credits:** 3 to 10 per course
 - a | 30 credits possible
 - b | **Important | only 15 credits can be used for diploma or certificate of achievement requirements**
- 2 | **Prerequisites:**
 - a | successfully complete Workplace Safety Systems (HCS 3000)
 - b | **must be 15 years of age or older and enrolled in high school**
- 4 | gain hands-on opportunities in various occupational areas
- 5 | develop employability skills necessary for success during and after high school
- 6 | no retroactive hours can be counted
- 7 | work must be supervised by the school-based Off-campus Coordinator

Career Internship 10

- 1 | **Credits:** 3, 4 or 5
- 2 | **Prerequisites:**
 - a | successfully complete Workplace Safety Systems (HCS 3000)
- 3 | discover career interests and aptitudes in trade, technology or service sectors
- 4 | work must be supervised by the school-based Off-campus Coordinator

Registered Apprenticeship Program (RAP)

- 1 | **Credits:** up to 40 Alberta Registered Apprenticeship Program credits
 - a | **Important | all 40 credits can be used for diploma or certificate of achievement requirements**
- 2 | **Prerequisites:**
 - a | successfully complete Workplace Safety Systems (HCS 3000)
 - b | recommended Workplace Safety Practices (HCS 3010)
 - c | **must be 15 years of age or older**
 - d | employment in a skilled trade
- 3 | work with CBE partner CAREERS: the Next Generation to find a position that fits with your interests and goals
- 4 | gain experience as an apprentice in a skilled trade of interest and earn high school credits
- 5 | training conducted by qualified journeypeople

K&E Workplace Readiness and Practicum -4

- 1 | **Credits:** 5
- 2 | **Prerequisites:**
 - a | none for Workplace Readiness 10-4
 - b | successfully complete Workplace Readiness 10-4 and 20-4 occupational courses for 20-4 Workplace Practicum courses
 - c | successfully complete 30-4 occupational course for 30-4 Workplace Practicum courses
 - d | see | [Appendix B | Part 2](#), **Figure 22** for a diagram of the pathways and prerequisites
- 3 | **Workplace Readiness 10-4**
 - a | prepares you for the world of work and enhances knowledge and skills acquired through K&E occupational courses
- 4 | **Workplace Practicum 20-4 and 30-4**
 - a | provide practical experiences for you to develop, apply and demonstrate employability skills
- 5 | take more than 1 practicum course at the 20 and 30 levels, depending on the number of completed prerequisite occupational courses 20-4 A,B,C,D & 30-4 A,B,C,D
- 6 | **Important |** Written consent and a learning plan are required to register in each K&E course.

Chinook Learning Services: S1 & S2 Work Experience

Chinook Learning Services offers Off-campus Coordinators to supervise S1 & S2 Work Experience to all current CBE high school students participating in the Calgary Police Cadets Program or the Calgary Fire Cadets Program, or working for the Calgary Flames Organization. If you participate in one these programs, you may be able to earn work experience credits.

- See the Off-campus Coordinator at your designated high school to explore this opportunity
 - **Learn more |** visit [Chinook Learning Services](#)

Unique Pathways

Note | Unique Pathways are added throughout the school year.

Learn More | for detailed descriptions about each of these opportunities and the most up-to-date information, visit [Unique Pathways and Off-campus Education](#).

Unique Opportunities are organized into three main categories:

- **Exploratory:** earn high school credit and industry credentials while exploring career possibilities. Learn from industry mentors in an authentic setting.
 - **Dual Credit:** earn high school and post-secondary credits at the same time. Some programs may also include industry credentialing.
 - **Internships:** participate in intensive experiences in the world of work and earn high school credits.
- **Important** | To earn Work Experience credits as part of an Exploratory or Internship program above, **a workplace safety course (HCS 3000) must be completed at your high school first.**

Fine and Performing Arts Choices

The Fine and Performing Arts are for everyone, whether you choose to explore and develop a new interest or specialize in a current interest. Participation in the arts enhances your creativity, critical thinking and problem solving abilities. These skills improve your performance in your academics, employment and life. Develop your ability to express yourself with confidence. **Dance, drama, music** and the **visual arts** build bridges across language and cultural differences.

The CBE has two Specialized Fine Arts Programs that have an application process that may include an interview, a portfolio review and/or an audition. This application process is an opportunity for program providers to determine your area of interest and readiness.

CBE Fine and Performing Arts Certificate

The CBE Fine and Performing Arts Certificate is available in all schools and is designed to recognize student commitment to exploring and developing interests and skills in the fine and performing arts. The criteria for the certificate includes:

- 1 | 30 credits from Fine Arts, Dance, Drama, Music and Visual Arts Courses in this guide and Leadership in the Arts 35.

Performing and Visual Arts (PVA)

- 1 | develop your skills, deepen knowledge and discover your own voice through the arts
- 2 | receive a **CBE Fine and Performing Arts Certificate** to recognize your achievement of credits in arts-related courses
- 3 | Performing and Visual Arts (PVA) is offered at [Central Memorial](#)
- 4 | **Application available at** | www.pvacentral.ca

Leadership in the Arts 35

This course provides the opportunity to specialize in one area of the Fine Arts (Dance, Drama, Music, or Visual Arts)

- **Important** | credits in a Leadership in the Arts 35 course can only be earned once although you will find the course listed under each of the Fine Arts
 - 1 | discover personal qualities necessary to engage, communicate and be successful in your chosen discipline (dance, drama, music, or visual arts)
 - 2 | understand how the arts contributes to emotional, social, and economic wellbeing of the community
 - 3 | engage in collaboration and networking with artists and art organizations

An Overview of Fine and Performing Arts Courses

Fine And Performing Arts Certificate

The Fine and Performing Arts are for everyone whether you chose to explore and develop a new interest or specialize in a current interest. Participation in the Arts enhances your creativity, critical thinking, and problem-solving abilities. In order to receive the Fine and Performing Arts Certificate, a minimum of 30 credits in the Fine and Performing Arts is required as well as Leadership in the Arts 35, or the Junior Achievement Entrepreneurial Artist opportunity. Students are able to determine their own personal pathway to achieving the certificate and may include courses from the Fine and Performing Arts, Career and Technology Studies, locally developed courses or related work experience.

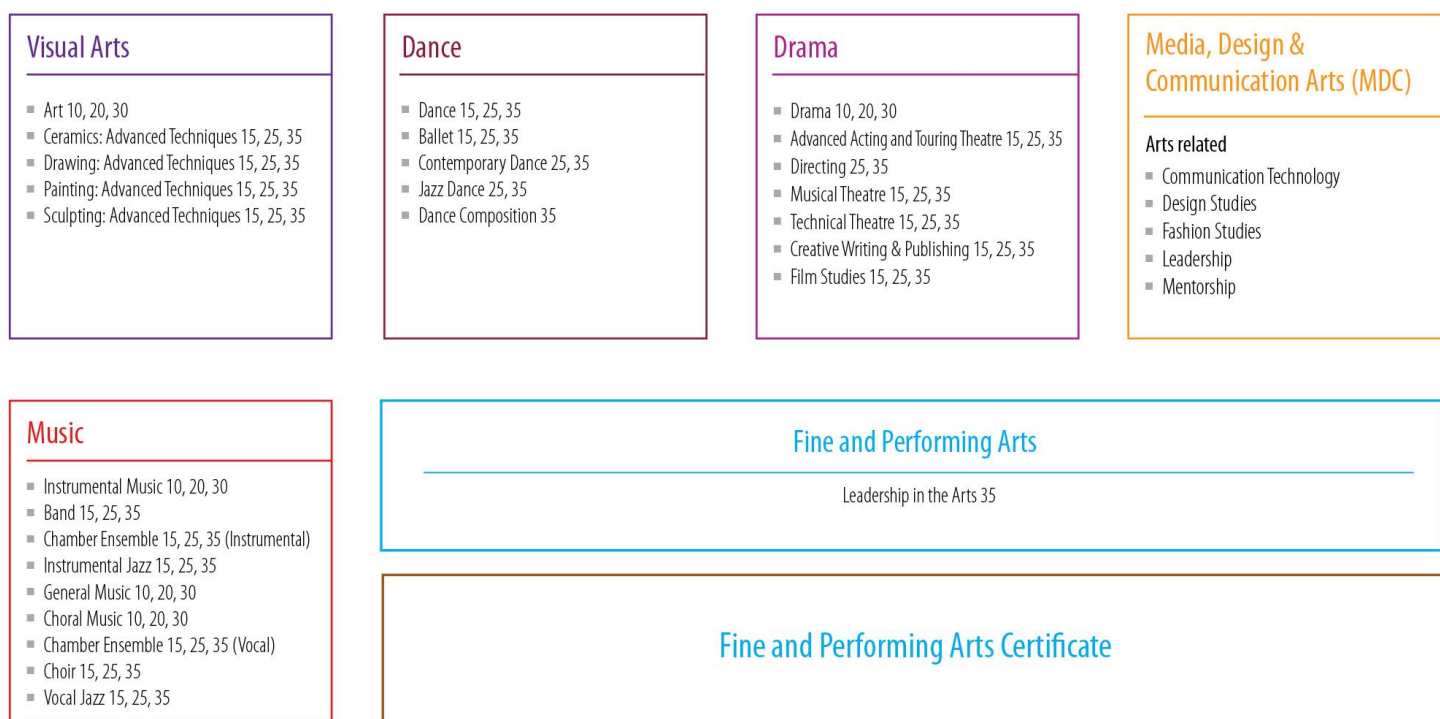

Important | If the arts are your passion, a CBE Fine and Performing Arts Certificate recognizes your achievement.

- <http://www.cbe.ab.ca/programs/program-options/Documents/Fine-Performing-Arts-Certificate.pdf>

Figure 3 | An Overview of Fine and Performing Arts Courses

Dance

Dance courses are designed to provide you with an opportunity to participate in various forms and aspects of dance. Dance allows you to focus on individual improvement in technique, strength, flexibility and style. As part of personalizing your learning, you can choose from a variety of dance courses and styles.

Dance 15, 25, 35

- 1 | **Credits:** 3 or 5 each
- 2 | **Prerequisites:**
 - a | none for Dance 15
 - b | successful completion of preceding level for 25 and 35 levels
 - c | enrolment without a prerequisite is permitted with the teacher's recommendation and principal's permission
 - d | **Important** | Dance 15 is the prerequisite for Contemporary Dance 25 and Jazz Dance 25
- 3 | improve creative expression, self-discipline, body awareness, motor coordination and all aspects of physical fitness such as strength, endurance, balance, agility, flexibility and grace
- 4 | think creatively and express thoughts and feelings in physical forms
- 5 | may include jazz (including but not limited to swing, classical, funk, hip hop ...) tap, modern / contemporary, creative, ethno cultural (including but not limited to Latin, African, Indo-Asian, Celtic ...), choreography and dance history
- 6 | develop confidence and stage presence through performance opportunities during the courses

Ballet 15, 25, 35

- 1 | **Credits:** 3 or 5 each
- 2 | **Prerequisites:**
 - a | none for Ballet 15
 - b | successful completion of preceding level for 25 and 35 levels
- 3 | continue to build strength, flexibility, coordination and expression
- 4 | progress at your own level and develop, appreciate and critique your own personal skill
- 5 | enhance technical proficiency and explore a personal interest in intensive study
- 6 | gain an understanding of ballet as an art form through contemporary and classical ballet

Contemporary Dance 25, 35

- 1 | **Credits:** 5 each
- 2 | **Prerequisites:**
 - a | successful completion of Ballet 15 or Dance 15 for 25 level
 - b | successful completion of Contemporary Dance 25 for 35 level
- 3 | experience a variety of styles, techniques and creative forms of modern and contemporary dance, such as modern, jazz, tap and social dance
- 4 | promotes dance as means of expression
- 5 | develops creative talents through technique, choreography and improvisation

Jazz Dance 25, 35

- 1 | **Credits:** 5 each
- 2 | **Prerequisites:**
 - a | successful completion of Dance 15 or Ballet 15 for Jazz Dance 25, and the 25-level of Jazz Dance for 35
- 3 | improve concentration and coordination through jazz progressions
- 4 | explore the process of jazz choreography based on steps acquired
- 5 | research the historical background of jazz and dance styles that affected its development

Dance Composition 35

- 1 | **Credits:** 5
- 2 | **Prerequisites:**
 - a | successful completion of Ballet 25 or Contemporary Dance 25 or Dance 25 or Jazz Dance 25
- 3 | develop an understanding and appreciation of the dance choreographer and the performance
- 4 | experience the role of choreographer – from concept/idea development, to audition, to the rehearsal process, to the production designs, and finally to the actual performance – in a safe, supportive environment
- 5 | learn concepts and tools to generate creative movement and ways to incorporate it into a composition

Leadership in the Arts 35 (Dance)

- 1 | **Credits:** 3 or 5
 - a | **Important** | Although you may take Leadership the Arts with a focus on Dance, Drama, Music or Visual Arts, **credits for successful completion of this course may only be earned once**
- 2 | **Prerequisites:**
 - a | must be enrolled in or have completed the appropriate Dance 30 courses
 - b | enrolment without prerequisites or co-requisites is permitted with the dance teacher's recommendation and permission of the principal
- 3 | develop a professional network and portfolio in your chosen art form
- 4 | **Learn more** | see [Leadership in the Arts 35](#) for a detailed course description



Drama

Drama develops you as a whole person - emotionally, physically, intellectually, imaginatively, aesthetically and socially. In drama courses, you study the elements of acting, technical theatre, playwriting and directing through various genres. By performing, collaborating and viewing authentic situations in theatre, you acquire greater appreciation and knowledge of yourself.

Drama 10, 20, 30

- 1 | **Credits:** 5 each
- 2 | **Prerequisites:**
 - a | none for Drama 10
 - b | successful completion of the preceding courses for 20 and 30
- 3 | develop performance and technical skills in eight dramatic disciplines (movement, speech, improvisation, acting, theatre studies, technical theatre design, playwriting and directing)
- 4 | develop your creativity and work with others to bring dramatic situations to life and become more confident in yourself and in collaboration
- 5 | demonstrate increased sophistication and refinement of skills as you advance

Advanced Acting and Touring Theatre 15, 25, 35

- 1 | **Credits:** 5 each
- 2 | **Prerequisites:**
 - a | 15-level no pre-requisite
 - b | 25-level is Advanced Acting and Touring Theatre 15
 - c | 35-level is Advanced Acting and Touring Theatre 25
- 3 | engage in extensive production work and application of skills and performance etiquette
- 4 | develop an understanding of theatre as an innovative form of performance art and communication reflecting diverse social, cultural and global perspectives
- 5 | develop a deep understanding of acting for stage and the theatre community

Directing 25, 35

- 1 | **Credits:** 5 each
- 2 | **Prerequisites:**
 - a | none for 25
 - b | successful completion of 25 for 35
- 3 | these courses are for you if you seek the challenge of interpreting and directing. You will have the opportunity to:
 - a | acquire and practise a variety of skills and techniques which enable you to become an effective director
 - b | develop an appreciation for the commitment required of leading an acting and technical ensemble

Film and Media Art 15, 25, 35

- 1 | **Credits:** 3 or 5 each
- 2 | **Prerequisites:**
 - a | none at 15 level
 - b | successful completion of preceding level OR demonstrated disciplinary knowledge and creative capacity for 25 and 35 levels
- 3 | create films and media arts to build technical proficiency, a sense of personal identity as an artist, and to express and understand film theory
- 4 | respond to and investigate a wide range of films and media arts
- 5 | collaborate with creative teams to learn the roles, language, techniques, and culture of the film industry and media arts discipline

Musical Theatre 15, 25, 35

- 1 | **Credits:** 5 each
- 2 | **Prerequisites:**
 - a | 15-level a co-requisite of one or more 10 or 15 level Performing Arts Course(s)
 - b | 25 and 35 levels require successful completion of the previous level
- 3 | provide an interactive environment of integrated study in dance, drama, technical theatre and vocal music for students who seek the challenge of working through the creative process to performance
- 4 | develop fundamental skills and discipline to become a proficient performer and artist in musical theatre
- 5 | evaluate and effectively reflect on your personal work and the work of your peers in live theatre production

Technical Theatre 15, 25, 35

- 1 | **Credits:** 3 or 5 each
- 2 | **Prerequisites:**
 - a | none for 15
 - b | 25 and 35 levels require successful completion of the previous level
- 3 | offer you an opportunity to explore and experience the skills necessary to realize a theatrical and public performance
- 4 | develop and demonstrate competencies in sound, lighting, set, costume, properties, make-up and stage management
- 5 | explore career opportunities by connecting with professional theatre communities

Leadership in the Arts 35 (Drama)

- 1 | **Credits:** 3 or 5
 - a | **Important** | Although you may take Leadership in the Arts with a focus on Dance, Drama, Music, or Visual Arts, **credits for successful completion of this course may only be earned once**
- 2 | **Prerequisites:**
 - a | must be enrolled in or have completed the appropriate Drama 30 courses
 - b | enrolment without prerequisites or co-requisites is permitted with the drama teacher's recommendation and permission of the principal
- 3 | develop a professional network and portfolio in your chosen art form
- 4 | **Learn more** | see [Leadership in the Arts 35](#) for a detailed course description

Music: Instrumental Music

Instrumental Music 10, 20, 30

- 1 | **Credits:** 3 or 5 each for 10 and 20 levels; 5 credits for the 30-level
- 2 | **Prerequisites:**
 - a | it is recommended that students have junior high instrumental music experience prior to enrolling in Instrumental Music 10 though not required
 - b | successful completion of previous levels for 20 and 30
- 3 | develop musical knowledge including: aural skills, technical skills, theory, musical style and history
- 4 | enhance musical skills including performance of scales, studies, sight-reading and a variety of repertoire
- 5 | may be offered as brass, percussion, woodwinds, strings, or various combinations, depending on the school

Band 15, 25, 35

- 1 | **Credits:** 3 or 5 each
- 2 | **Prerequisites and Co-requisites:**
 - a | recommended that students take the courses in sequence and accompanied by Instrumental Music 10-20-30
- 3 | apply personal practice strategies in an ensemble setting
- 4 | interpret select music creatively and critically
- 5 | rehearse repertoire and perform publicly with a large group or ensemble
- 6 | explore and apply elements of quality performance and performance etiquette

Chamber Ensemble 15, 25, 35 (Instrumental)

- 1 | **Credits:** 3 or 5 each
 - a | **Important** | for flexibility this course may be offered for a choral or instrumental ensemble; **credits can only be earned once**
- 2 | **Prerequisites and Co-requisites:**
 - a | recommended that students take the courses in sequence and accompanied by Instrumental Music 10-20-30
- 3 | apply personal practice strategies in a smaller and often self-directed, vocal and/or instrumental ensemble setting
- 4 | rehearse repertoire and perform publicly with a small group or ensemble
- 5 | explore and apply elements of quality performance and performance etiquette

Instrumental Jazz 15, 25, 35

- 1 | **Credits:** 3 or 5 each
- 2 | **Prerequisites and Co-requisites:**
 - a | recommended that students take the courses in sequence and accompanied by Instrumental Music 10-20-30
- 3 | refine musicianship in jazz through listening, analysing, practicing, performing and assessing
- 4 | apply diverse components of jazz
- 5 | develop and apply theoretical understanding of structure, form and nuances that are specific to jazz
- 6 | improvise, arrange and create original ideas and material

Enrolment without the recommended course sequence and/or the co-requisite is permitted with the music teacher's recommendation and the permission of the principal.

Leadership in the Arts 35 (Music: Instrumental focus)

- 1 | **Credits:** 3 or 5
 - a | **Important** | Although you may take Leadership in the Arts with a focus on Dance, Drama, Music, or Visual Arts, **credits for successful completion of this course may only be earned once.**
- 2 | **Prerequisites:**
 - a | must be enrolled in or have completed the appropriate Music 30 courses
 - b | enrolment without prerequisites or co-requisites is permitted with the music teacher's recommendation and permission of the principal
- 3 | develop a professional network and portfolio in your chosen art form
- 4 | **Learn more** | see [Leadership in the Arts 35](#) for a detailed course description

Music: Choral Music

Music expresses our deepest emotions and inspires us, whether it be to reach across cultures or to take political action. Albert Einstein asserted, "If I were not a physicist, I would probably be a musician. I often think in music. I live my daydreams in music. I see my life in terms of music." In music courses, express yourself and belong to a team while learning music literacy, skills, and techniques.

Choral Music 10, 20, 30

- 1 | **Credits:** 3 or 5 each for 10 and 20 levels; 5 credits for 30-level
- 2 | **Prerequisites:**
 - a | 10-level none
 - b | successful completion of previous levels for 20 and 30 levels
- 3 | explore vocal technique, literacy, sight singing, musicianship and history
- 4 | focus on choral ensemble skills, individual development of singing tone, musical literacy and skills related to pitch and rhythm
- 5 | develop your musical skills in a challenging and encouraging environment

Chamber Ensemble 15, 25, 35 (Vocal)

- 1 | **Credits:** 3 or 5 each
 - a | **Important** | for flexibility this course may be offered for a choral or instrumental ensemble; **credits can only be earned once**
- 2 | **Prerequisites and Co-requisites:**
 - a | recommended that students take the courses in sequence and accompanied by Instrumental Music 10-20-30
- 3 | apply personal practice strategies in a smaller and often self-directed vocal, and/or instrumental ensemble setting
- 4 | rehearse repertoire and perform publicly with a small group or ensemble
- 5 | explore and apply elements of quality performance and performance etiquette

Choir 15, 25, 35

- 1 | **Credits:** 3 or 5 each
- 2 | **Prerequisites and Co-requisites:**
 - a | recommended that students take the courses in sequence and accompanied by Choral 10-20-30
- 3 | apply and extend personal practice strategies in a choir
- 4 | rehearse repertoire and perform publicly in a choir
- 5 | explore and apply elements of quality performance and performance etiquette

GO FOR IT |

Fine &
Performing
Arts |

Vocal Jazz 15, 25, 35

- 1 | **Credits:** 3 or 5 each
- 2 | **Prerequisites and co-requisites:**
 - a | recommended that students take the courses in sequence and accompanied by Choral 10-20-30 or Choir 15-25-35
- 3 | build understanding of repertoire and techniques involved in performance of vocal jazz through the exploration, practice and performance of vocal jazz
- 4 | apply the diverse aspects and components of vocal jazz
- 5 | develop and apply theoretical understanding of rhythmic patterns, chordal textures and harmonies that are specific to the jazz genre

Leadership in the Arts 35 (Music: Vocal focus)

- 1 | **Credits:** 3 or 5
 - a | **Important** | Although you may take Leadership in the Arts with a focus on Dance, Drama, Music, or Visual Arts, **credits for successful completion course may only be earned once**
- 2 | **Prerequisites:**
 - a | must be enrolled in or have completed the appropriate Music 30 courses
 - b | enrolment without prerequisites or co-requisites is permitted with the music teacher's recommendation and permission of the principal
- 3 | develop a professional network and portfolio in your chosen art form
- 4 | **Learn more** | see [Leadership in the Arts 35](#) for a detailed course description

Music: General Music

General Music 10, 20, 30

- 1 | **Credits:** 3 or 5 each
- 2 | **Prerequisites:**
 - a | none for 10; successful completion of the previous levels for 20 and 30
- 3 | develop fundamental and applicable musical skills for performance, appreciation and creative expression
- 4 | build musical literacy through understanding concepts of pitch, rhythm, form, style and historical perspective
- 5 | learn about instruments, voice, technology, composition and current trends through a variety of opportunities



Visual Arts

Explore ideas and imagine possibilities—in Visual Arts courses engage with techniques and ways of thinking of artists to create your own representations of meaning.

Art 10, 20, 30

- 1 | **Credits:** 3,4, or 5 each for Art 10 and 20; 5 for Art 30
- 2 | **Prerequisites:**
 - a | 10-level none; successful completion of preceding levels for higher levels
- 3 | practice and refine drawing, sketching, and composition skills and techniques
- 4 | extend knowledge and familiarity of design elements and principles to develop personal style in two and three dimensional images
- 5 | use art criticism to analyse and evaluate your work and the work of others
- 6 | at higher levels investigate technology's impact on the artist's intentions and production
- 7 | question sources of images that are personally relevant

Art 11, 21, 31

- 1 | **Credits:** 3,4, or 5 each for Art 11 and 21; 5 credits for Art 31
- 2 | **Prerequisites:**
 - a | 11-level none; successful completion of preceding levels for higher levels
- 3 | complements Art 10–20–30 by examining the role art plays in people's lives, how it comes into being, and how people respond to it
- 4 | focuses on three major components of learning in the visual arts: function, creation, appreciation
- 5 | survey the role of the artefact in everyday life in Art 11; survey the history of art in Western culture and the changing view of art in Art 21; examine the impact of international influences and modern technology on modern art, and modern art's impact on society in Art 31

Ceramics: Advanced Techniques: 15, 25, 35

- 1 | **Credits:** 5 each
- 2 | **Prerequisites:**
 - a | none for Ceramics 15
 - b | successful completion of preceding levels for higher course levels
- 3 | become familiar with a variety of ceramic processes and techniques from shaping and manipulating a wet medium through to the product of the kiln
- 4 | learn traditional craftsmanship and become knowledgeable about ceramics through studio practice

Drawing: Advanced Techniques 15, 25, 35

- 1 | **Credits:** 5 each
- 2 | **Prerequisites:**
 - a | none for Drawing 15
 - b | 25-level successful completion of 15-level or a 5-credit Art 10, or 60% or more in a 3-credit Art 10 course
 - c | 35-level successful completion of 25 level, or 60% or better in Art 20 and consent of the department
 - d | **Important** | retroactive credits are not available for students entering Advanced Techniques Drawing at the 25 or 35-level
- 3 | communicate visually through the study of sources for images, materials and methods, selection and arrangement, critiquing and studio practice
- 4 | become an informed creator of solutions to visual problems and practice self-confidence in creative thinking, symbolic representation and communicating visually
- 5 | appreciate the significance of drawing

Painting: Advanced Techniques 15, 25, 35

- 1 | **Credits:** 5 each
- 2 | **Prerequisites:**
 - a | none for Painting 15
 - b | Painting 25 requires successful completion of Painting 15 or Art 10
 - c | Painting 35 requires successful completion of Painting 25 or Art 20
- 3 | provide the opportunity to engage in extended exploration of painting
- 4 | develop specific technical abilities in both traditional and non-traditional painting, and work in variety of material
- 5 | provide extensive studio practice and portfolio creation

Sculpting: Advanced Techniques 15, 25, 35

- 1 | **Credits:** 5 each
- 2 | **Prerequisites or co-requisites:**
 - a | Art 10 is pre-requisite / co-requisite for Sculpting 15
 - b | Sculpting 25 requires successful completion of Art 10 or Sculpture 15
 - c | Sculpting 35 requires successful completion of Art 20 or Sculpture 25
- 3 | use imagination to create original sculpture to express yourself for a variety of audiences and purposes
- 4 | develop aesthetic awareness of sculpting as a distinct form of art and communication that reflects diverse social, cultural and global perspectives
- 5 | develop understanding of the sculpting process through the study of form and space, surface, history of sculpture, and the manipulation, assembly, and/or transformation of a variety of materials
- 6 | learn how to become an informed creator of solutions to sculptural problems through critique, studio-management and safe studio practice

Leadership in the Arts 35 (Visual Arts)

- 1 | **Credits:** 3 or 5
 - a | **Important** | Although you may take Leadership in the Arts with a focus on Dance, Drama, Music, or Visual Arts, **credits for successful completion of the course can only be earned once**
- 2 | **Prerequisites:**
 - a | must be enrolled or have completed the appropriate Art 30 courses
 - b | enrolment without prerequisites or co-requisites is permitted with the art teacher's recommendation and permission of the principal
- 3 | develop a professional network and portfolio in your chosen art form
- 4 | **Learn more** | see [Leadership in the Arts 35](#) for a detailed course description



Languages | Programs and Courses

Learning a language empowers you to think, act, and speak in diverse cultural settings widest range of language programs and courses in Calgary.

- 1 | **Immersion Program:** offers instruction of various subjects **in French**.
 - a | **Early Immersion** begins in Kindergarten or Grade 1 with French being the main language of instruction and learning.
 - b | **Late Immersion** starts in Grade 7 with French being the main language of instruction and learning.
- 2 | **French as a Second Language (FSL)** is for you if your first language is not French or you have not been in French Immersion classes.
 - a | 3Y language instruction starts in Grade 10
 - b | 6Y language instruction started in Grade 7
 - c | 9Y language instruction started in Grade 4
- 3 | **Bilingual Programs and Courses:** instruction occurs in both English and another international language, other than French. In the CBE, bilingual instruction in high school is currently available in: **Spanish** and **American Sign Language**
 - a | Other bilingual language programs may be offered when there is sufficient enrolment
- 4 | **Language and Culture Courses**
 - a | currently Language and Culture courses are offered in American Sign Language, Chinese, German, **Latin, Japanese**, Punjabi and Spanish
 - b | support the development of oral, reading and writing skills in the target language
 - c | develop oral and written skills in an international language
 - d | provide a safe place for students to practice communication skills in the target language in various contexts and for different purposes
 - 3Y language instruction starts in Grade 10
 - 6Y language instruction started in Grade 7
 - 9Y language instruction started in Grade 4
 - e | **Important** | If you have experience with another language, you may want to consider a Course Challenge, if available. See [Appendix D](#) | Course Challenge–Questions and Answers

***Note** | Talk to your school counsellor or use the [Find a School](#) link to learn about which of these schools provides these programs of choice.

*The French Immersion Program is offered at:	*The Spanish Bilingual Program is offered at:
William Aberhart High School Western Canada High School Dr. E. P. Scarlett High School	William Aberhart High School in the North Grade 12 Dr. E. P. Scarlett High School in the South Grade 12 Crescent Heights Grade 10 & 11
Learn more for more information use the link to Early French Immersion or Late French Immersion Learn more use Find A School to learn which high school offers French Immersion for you.	Learn more for more information use the link to Spanish Bilingual Program Learn more use Find A School to learn which high school offers the Spanish Bilingual program for you.

Table 3 | Locations for French Immersion and Spanish Bilingual Programs of Choice

GO FOR IT |

Languages

In FLA 30-1, you write a **provincial Diploma Exam**, worth 30% of your final grade. . The percentage weighting for diploma exams is at the discretion of Alberta Education.

Note | FLA does NOT replace the English Language Arts (ELA) Diploma requirement.

French Language Arts (FLA / Immersion)

French Language Arts (FLA) is for students continuing in the French Immersion program. You continue to extend your French proficiency. As you expand your horizons in one of Canada's official languages, you will enhance your speaking, listening, reading and writing competencies in French. While creating oral and written presentations, you will learn to plan, elaborate and justify your opinions. You will cultivate a deep appreciation of French language and culture across the globe.

FLA 10-1, 20-1, 30-1

- 1 | **Credits:** 5 each
- 2 | **Prerequisites:**
 - a | successful completion: FLA grade 9 for 10-1
 - b | successful completion of preceding courses for 20-1 and 30-1 levels.
- 3 | develop your oral comprehension in varied communication situations
- 4 | produce and participate in oral presentations to enhance verbal skills
- 5 | interact with literary and informational texts as well as multimedia
- 6 | compose literary and persuasive texts
- 7 | view French as a means for personal, intellectual and social development

FLA 10-2, 20-2, 30-2

- 1 | **Credits:** 5 each
- 2 | **Prerequisites:**
 - a | FLA 9 for 10-2
 - b | successful completion of the preceding levels for 20-2 and 30-2
- 3 | produce and participate in oral presentations to enhance verbal skills
- 4 | produce and present orally to enhance verbal communication skills
- 5 | develop reading comprehension using informational and multi-media texts
- 6 | compose expository, descriptive and persuasive texts
- 7 | view French as a means for personal, social and professional development
- 8 | **Important** | there is no Diploma Exam at the end of FLA 30-2

Other Academic Courses in French for Immersion Students

If you are in the French Immersion Program, the following courses are taught in French:

- 1 | Math 10C, 20-1, 30-1 and Math 20-2, 30-2
- 2 | Math 31 is provided in French in some high schools
- 3 | Social 10-1, 20-1, 30-1 and Social 10-2, 20-2, and 30-2

At the 30-level, Math and Social Diploma Exams are offered in French. Science courses and the Science Diploma Exams are only offered in English.

CBE Certificate of Achievement in French Immersion

The criteria for a CBE Certificate of Achievement in French Immersion includes:

- 1 | 45 credits from courses taught in French
 - a | 15 credits must come from **French Language Arts** courses
 - b | earn remaining 30 credits by taking math and social courses in French (they follow the regular Alberta Program of Studies, but are taught in French)
 - c | **Recommendation** | take at least 1 French Immersion course each semester if you want to work toward this CBE certificate and your high school Diploma
- 2 | 80% average or more earns a Certificate of Achievement in French Immersion 'with distinction'

Note | If you do not complete all 45 credits in French Immersion, you receive an official Letter of Achievement indicating the number of credits you earned from courses in French.

French as a Second Language (FSL)

French as a Second Language (FSL) in high school focuses on understanding and expressing yourself in basic situations in French through an action-oriented approach.

FSL 10-3Y, 20-3Y, 30-3Y

- 1 | **Credits:** 5 each
- 2 | **Prerequisites:**
 - a | none for 10-level
 - b | successfully complete the 10-3Y course or Grade 9 French for the 20-level
 - c | successfully complete the 20-level for the 30-level
- 3 | understand and express in French, messages related to your personal, educational, express in French your personal, interpersonal and imaginative language functions
- 4 | build strategies to develop your vocabulary, language structures and cultural understandings

FSL 10-9Y, 20-9Y, 30-9Y

- 1 | **Credits:** 5 each
 - 2 | **Prerequisites:**
 - a | successful completion of FSL 9 for 10-9Y
 - b | successful completion of the preceding courses for 20 and 30 levels
- Each grade is the building block for the next. You will:
- 3 | experience communication, language, culture and language learning strategies
 - 4 | explore French through physical, social, civic, intellectual and leisure activities
 - 5 | build your communication skills through comprehension, production and negotiation
 - 6 | develop cultural understandings and knowledge through language

French 31a, 31b, 31c

- 1 | **Credits:** 5 each
- 2 | **Prerequisites:**
 - a | successful completion of FSL 30-3Y
 - b | successful completion of preceding levels for 31b and 31c
- 3 | engage in various language experiences based on a variety of themes
- 4 | express yourself orally and in writing in diverse situations
- 5 | interpret oral and written communications
- 6 | understand and use the French sound-symbol system and vocabulary related to the themes studied
- 7 | develop strategies to understand and communicate effectively
- 8 | analyse the contribution of Francophone cultures to our society

Note | A bilingual language arts course does **NOT** replace the diploma requirement for a 30-level English Language Arts course. **You must successfully complete English 30-1 or 30-2** to earn your high school Diploma.

Bilingual Programs and Courses

American Sign Language (ASL): Bilingual-Language Arts 15, 25, 35

- 1 | **Credits:** 5 each
- 2 | **Prerequisites:**
 - a | **only open** to students in the Deaf and Hard of Hearing Program at Queen Elizabeth High School
 - b | for the 15-level, experience with Grade 9 ASL Bilingual Language Arts
- 3 | explore thoughts, ideas, feelings and experiences with ASL
- 4 | comprehend and respond personally and critically to literary and media texts with ASL
- 5 | manage ideas and information with ASL
- 6 | enhance the clarity and artistry of communication with ASL
- 7 | celebrate and build community with ASL

Spanish Bilingual Program

The Spanish Bilingual Program provides students with the opportunity to maintain and improve the skills of listening, speaking, reading, and writing in Spanish acquired in the bilingual K-9 program. The schools that offer the Spanish Bilingual Program are part of the International Spanish Academy network.

Spanish Language Arts (SLA) 10, 20, 30 Bilingual Course

- 1 | **Credits:** 5 each
 - a | successful completion of K to 9 Spanish Bilingual Program for SLA 10 or at the discretion of the principal
 - b | successful completion of the preceding courses for 20 and 30
- 2 | continue the Spanish bilingual program with opportunities to develop fluency in Spanish to feel at ease in a variety of communication situations
- 3 | study a variety of texts (including print, audio, visual multi-media)
- 4 | enhance vocabulary, grammar, sentence structure and mechanics to communicate effectively for different audiences and purposes
- 5 | develop strong knowledge and understanding of culture and language that promote effective global citizenship and enhance career potential
- 6 | collaborate to develop inquiry questions to focus on a topic and purpose
- 7 | communicate personal needs in relation to audience and purpose
- 8 | **Important** | To complete the Spanish Bilingual Program:

Student must complete 25 % of courses in Spanish

SLA 10/20/30

and

Core or Option courses to be determined.

International Language and Culture Choices

Each Language and Culture course develops communication competencies in international languages. In an international language course, you:

- 1 | communicate orally and in writing for various contexts and purposes
- 2 | acquire effective language learning strategies
- 3 | gain insights into historical and contemporary elements of another culture

depending on when you started learning the language.

3Y level: Language Instruction starts in Grade 10

- 1 | **Credits:** 5 each
- 2 | **Prerequisites:**
 - a | none for 10 or 15-level
 - b | successful completion of preceding course for 20-3Y and 30-3Y or 25-3Y and 35-3Y

These courses are for you if you have little or no prior experience. You will develop your ability to:

- 3 | understand simple sentences; simple familiar and unfamiliar short texts
- 4 | produce short texts in a variety of topics providing some details to support the main point with guidance
- 5 | make requests and suggestions in a variety of situations
- 6 | inquire about others' views; state and support your point of view
- 7 | initiate and participate in casual exchanges with classmates

6Y level: Language instruction started in Grade 7

- 1 | **Credits:** 5 each
- 2 | **Prerequisites:**
 - a | successful completion of previous levels in this course sequence for 10-6Y
 - b | successful completion of preceding course for 20-6Y & 30-6Y

These courses will develop your ability to:

- 3 | share detailed information on a specific topic
- 4 | compare the expressions of emotions and feelings in formal and informal situations
- 5 | produce short oral and written texts on unfamiliar topics with guidance
- 6 | take on a leadership role in small-group projects

9Y level: Language instruction started in Grade 4

- 1 | **Credits:** 5 each
- 2 | **Prerequisites:**
 - a | successful completion of previous levels in this course sequence 10-9Y
 - b | successful completion of preceding course for 20-9Y & 30-9Y

These courses will develop your ability to:

- 3 | initiate and participate in social exchanges in formal and informal situations
 - 4 | synthesize information from several sources and evaluate the usefulness and reliability of sources
 - 5 | understand and produce lengthy oral texts on a variety of topics providing details to support main ideas
- converse, spontaneously, on familiar topics

10-12Y level: Language Instruction started in Kindergarten or Grade 1

- 1 | **Credits:** 5 each
- 2 | **Prerequisites:**
 - a | successful completion of previous levels in the same course sequence for 10-12Y
 - b | successful completion of preceding course for 20-12Y & 30-12Y

GO FOR IT |

Languages

International Language and Culture Course Sequences

The following Language and Culture Courses are offered in various CBE high schools.

Important | all of these courses are offered based on enrollment.

American Sign Language and Deaf Culture 15-3Y, 25-3Y, 35-3Y

Chinese Language and Culture 10-3Y, 20-3Y, 30-3Y

Chinese Language and Culture 10-6Y, 20-6Y, 30-6Y

German Language and Culture 10-3Y, 20-3Y, 30-3Y

German Language and Culture 10-6Y, 20-6Y, 30-6Y

German Language and Culture 10-9Y, 20-9Y, 30-9Y

Latin Language and Culture 10-3Y, 20-3Y, 30-3Y

Punjabi Language & Culture 10-3Y, 20-3Y, 30-3Y

Spanish Language & Culture 10-3Y, 20-3Y, 30-3Y

Spanish Language & Culture 10-6Y, 20-6Y, 30-6Y

Spanish Language & Culture 10-9Y, 20-9Y, 30-9Y



Complementary Courses

Aboriginal Studies

Aboriginal Studies 10, 20, 30

- 1 | **Credits:** 3 or 5 each
- 2 | **Prerequisites:**
 - a | Recommended preceding levels for each higher level

These courses welcome all who are interested in delving deeper into:

- 1 | political and economic organizations of Aboriginal cultures (Aboriginal Studies 10)
- 2 | cultural change as it relates to the Métis, treaties, legislation and schooling (Aboriginal Studies 20)
- 3 | Aboriginal rights, land claims and self-governance (Aboriginal Studies 30)
- 4 | **Learn more** | visit [Unique Pathways & Off-campus Education](#)
- 5 |

These courses are experiential in nature (including field trips and presentations by Elders and the community), and build understandings of Aboriginal peoples of Canada and Indigenous peoples of the world in the context of history and contemporary issues.

Treaties and Sovereignty 15

- 1 | **Credits:** 3
- 2 | **Prerequisites:**
 - a | none

These courses welcome all of you who are interested in delving deeper into:

- treaty relationships between local First Nation(s) and Canada
- historical perspectives and contemporary views on current treaties and the treaty making process
- impacts of policies from treaties on First Nations peoples

Traditional Land Based Learning 25-35

- 1 | **Credits:** 3 or 5 each
- 2 | **Prerequisites:**
 - a | 25 First Aid/CPR with AED (HCS20200 Food Basic (FOD1010) Workplace Safety Systems (HCS3030) Construction Tools & Materials (CON1010) Introduction to Stewardship
 - b | Recommended preceding levels for each higher level

These courses welcome all of you who are interested in delving deeper into:

- an enhanced understanding of cultural identity, health, and personal success
- shared traditions and cultural values as communicated by Elders and Knowledge Keepers
- science and technology as potential career pathways

These courses are experiential in nature (including field trips and presentations by Elders and the community).

English Language Arts (ELA)

ELA complementary courses do **NOT** replace the required English Language Arts courses for a Diploma or Certificate of High School Achievement.

Creative Writing and Publishing 15, 25, 35

- 1 | **Credits:** 3 or 5
- 2 | **Prerequisites:**
 - a | none for 15-level
 - b | preceding levels for 25 and 35 courses required
- 3 | create original texts
- 4 | collaborate with peers and the writing community
- 5 | understand and evaluate creative writing markets and the submission process
- 6 | manage the publication process

Journalism 15, 25, 35

- 1 | **Credits:** 5 each
- 2 | **Prerequisites:**
 - a | none for 15-level
 - b | preceding levels for 25 and 35 courses required
- 3 | understand and evaluate the impact, responsibility and ethics of media in society
- 4 | understand audience and purpose in relation to journalistic texts
- 5 | create and publish media texts
- 6 | apply technology effectively to enhance production of print and multimedia texts
- 7 | collaborate and problem solve while creating media texts
- 8 | apply the skills of analysis, self-evaluation and goal setting in the production and post-production process

Reading 15, 25

- 1 | **Credits:** 3 or 5
- 2 | **Prerequisites:**
 - a | none for Reading 15
 - b | Reading 15 required for Reading 25
- 3 | acquire, apply and adapt personal strategies, **before reading**, to assist in activating prior knowledge and anticipating the meaning of texts
- 4 | acquire, apply and adapt personal strategies, **during reading**, to assist in constructing the meaning of texts
- 5 | acquire, apply and adapt personal strategies, **after reading**, to assist in interpreting, challenging and deliberating upon the meaning of texts
- 6 | demonstrate and enact the attitudes and characteristics necessary for reading fluency
- 7 | read for information, enjoyment and for engagement in the world

Interdisciplinary

Design Thinking for Innovation 15, 25, 35

- 1 | **Credits:** 3 or 5 each
- 2 | **Prerequisites:**
 - a | none for 15 level
 - b | preceding level for 25 and 35 levels or demonstrate disciplinary knowledge and creative capacity
- 3 | learn, apply and demonstrate design thinking processes and methods to develop creative solutions to design challenges
- 4 | develop communication and collaboration skills need to broaden potential solutions to design challenges
- 5 | build research, investigation, experimentation, and prototyping skills
- 6 | enhance critical, analytical, and creative thinking skills

Learning Competencies

Expanded Core Curriculum for Students with Visual Impairments 15, 25

- 1 | **Credits:** 3 or 5 each at the 15 level; 3 at the 25 level
- 2 | **Prerequisites:**
 - a | none for 15 level
 - b | 15 level required for 25 level
- 3 | extend your skills of assistive technologies (such as, but not limited to, video magnification, operating system modifications, electronic texts and eBooks, mobile devices, Braille notetakers, and/or screen readers with Braille display for low vision, Braille user, and/or dual users)
- 4 | apply technologies and visual efficiencies to enhance your academic, personal, and professional success

Learning Strategies 15, 25, 35

- 1 | **Credits:** 3 or 5
- 2 | **Prerequisites:**
 - a | none for 15 level
 - b | Learning Strategies 15 (3 or 5 credit) for 25 level
 - c | Learning Strategies 25 (3 or 5 credit) 35 level
- 3 | explore, collaboratively develop, reflect on and revise and apply strategies to:
 - a | effectively manage time and resources, both human and material
 - b | promote independent and interdependent relationships
 - c | select personal learning strategies that are effective in a variety of academic contexts
 - d | recognize occasions and advocate when it is necessary to seek and offer support with increasing confidence

Social Literacy 15, 25

- 1 | **Credits:** 3 each
- 2 | **Prerequisite:**
 - a | none for 15 level
 - b | Social Literacy 15 for 25 level
- 3 | discover, develop and apply social competencies in school, work and the community. effectively manage time and resources
- 4 | explore and demonstrate understanding of appropriate verbal, non-verbal and electronic communication strategies in a variety of social situations
- 5 | develop socially appropriate strategies to build and maintain relationships in a variety of contexts
- 6 | demonstrate understanding of social problem solving processes and implement adaptive strategies

Mathematics

Math complementary courses do **NOT** replace the required Math for courses for a Diploma or Certificate of High School Achievement.

Competencies in Math 15

- 1 | **Credits: 5**
- 2 | **Prerequisite:**
 - a | none
- 3 | improve student mastery of mathematical skills, concepts and ideas.
- 4 | extend knowledge beyond performing routine operations
- 5 | explore a deeper understanding of mathematical concepts through critical thinking and exploration exercises
- 6 | students will collaborate with their teacher and peers to explore multiple ways to solve problems.

Math Analysis and Approaches 25-35

- 1 | **Credits: 25 – 5 credits, 35 – 3 credits**
- 2 | **Prerequisite:**
 - a | 25 | Math 10C
 - b | 35 | Math 20-1
- 3 | improve student mastery of analytical thinking as it applies to mathematics
- 4 | covers topics typically covered in pre-university courses as well as topics that encourage investigation, conjecture and proof
- 5 | encourages use of technology as applies to mathematics
- 6 | encourages students to further develop abilities to construct, communicate and justify mathematical arguments

Science

Astronomy 15, 25, 35

- 1 | **Credits: 3 each**
- 2 | **Prerequisite or Co-requisite:**
 - a | Astronomy 15: none
 - b | Astronomy 25: Science 10 or preceding course
 - c | Astronomy 35: Science 20 or preceding course
- 3 | analyze, assess and refine connections between celestial observations, human exploration, creativity, innovation, technological advancements and innate curiosity through a scientific inquiry model
- 4 | extend and deepen understanding of astronomical principles
- 5 | develop and apply skills of observing and documenting the objects visible in the day and night skies

Science complementary courses do **NOT** replace the required Science for courses for a Diploma or Certificate of High School Achievement.

Environmental Studies: Advanced 35

- 1 | **Credits: 5**
- 2 | **Prerequisites:**
 - a | Biology 20
 - b | Math 20
- 3 | conduct field research, make discoveries and learn to see the world through a critical and analytic lens
- 4 | engage in innovative and ethically sound discussions, challenges solutions
- 5 | learn about topics like energy consumption, pollution and its impact on human health
- 6 | and the economy, population dynamics and ecosystem structures

Epidemiology: Study of Pandemics

- 1 | **Credits:** 3 or 5
- 2 | **Prerequisites:**
 - a | none
- 3 | investigate and evaluate the processes involved in a pandemic
- 4 | learn about the socio-biological history of past pandemics, case studies, genesis of viruses, evolution of viruses and vaccinations
- 5 | analyze the strengths and limitations of public health and disease control strategies
- 6 | explore potential occupations and career pathways in the field of epidemiology

Forensic Studies 25, 35

- 1 | **Prerequisites:**
 - a | Science 10 or Science 14 for Forensic Studies 25
 - b | Forensic Studies 25 for Forensic Studies 35
- 2 | connect scientific concepts and technologies related to solving crime
- 3 | learn about topics like crime scene investigation, forensics, toxicology and ballistics, police protective equipment, criminal profiling, arson and police service canines

Synthetic Biology 15

- 1 | **Credits:** 3
- 2 | **Prerequisite:**
 - a | none
- 3 | understand and explain the fundamental concepts of molecular biology, and how these concepts are used in genetic engineering and the new field of synthetic biology
- 4 | evaluate information and data competently and critically, and design a synthetic biology project aimed at solving a problem relevant to you and your community (learn to research effectively)
- 5 | apply the main principles and techniques of scientific inquiry as they pertain to a understand the importance of the safety and ethical implications of synthetic biology, and apply an open-minded and responsible approach to our project
- 6 | collaborate with others and communicate research ideas using various media

Science complementary courses do **NOT** replace the required Science for courses for a Diploma or Certificate of High School Achievement.



Social Sciences

Social Sciences Complementary Courses

Social Science complementary courses allow you to explore relationships among individuals in various societies on a deeper level.

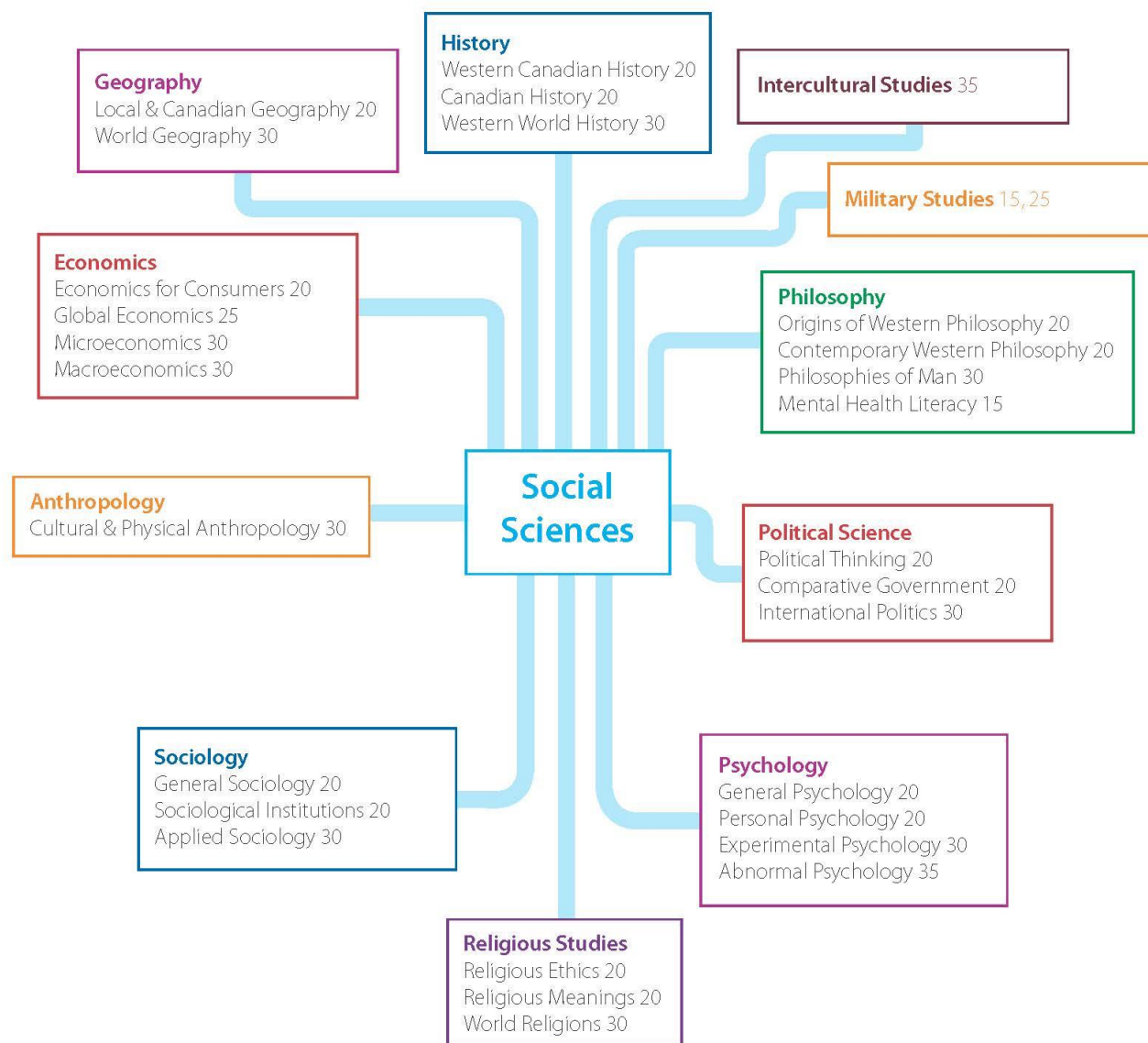

Figure 4 | An Overview of the Social Sciences Complementary Course Choices

Social Science complementary courses do **NOT** replace the required Social Studies courses for a Diploma or Certificate of High School Achievement.

Social Science complementary courses with an International focus may be used to meet part of the requirements for a [CBE International Certificate](#).

Social Sciences

Anthropology

Cultural and Physical Anthropology 30

- 1 | **Credits:** 3
- 2 | **Prerequisites:**
 - a | none
- 3 | demonstrate and utilize methods, techniques and tools of anthropologists to examine the historical development and change of human culture from the Palaeolithic Era to modern times

Economics

Economics for Consumers 20

- 1 | **Credits:** 3
- 2 | **Prerequisites:**
 - a | none
- 3 | understand how general economic principles like income, expenditures and inflation govern personal choice in everyday situations
- 4 | appreciate the ways in which economic conditions influence decision-making in the consumer and capital marketplace

Microeconomics 30

- 1 | **Credits:** 3
- 2 | **Prerequisites:**
 - a | none
- 3 | expand understanding of how economics influences individuals in everyday lives
- 4 | examine the structure, theory and function of economic systems and how individuals and firms interact in the marketplace
- 5 | understand the influence of organized labour and collective bargaining in economic systems

Macroeconomics 30

- 1 | **Credits:** 3
- 2 | **Prerequisites:**
 - a | none
- 3 | gain a historical perspective of economics principles, theories and systems
- 4 | learn about the function of money and banking in economic systems
- 5 | understand the influence and control of government in economic systems
- 6 | explore the nature of economies in developing countries

Geography

Local and Canadian Geography 20

- 1 | **Credits:** 3
- 2 | **Prerequisites:**
 - a | none
- 3 | learn about the interaction between geographic factors and human settlement patterns in urban and rural areas, including Western Canada and Eastern Canada

GO FOR IT |

Social Sciences Complementary Courses

World Geography 30

- 1 | **Credits:** 3
- 2 | understand and identify elements of physical geography as they relate to patterns of population and settlement
- 3 | learn about how human settlement and the utilization of natural resources have impacted the Earth

History

Western Canadian History 20

- 1 | **Credits:** 3
- 2 | **Prerequisites:**
 - a | none
- 3 | utilize a historical perspective to understand the complex series of events that encompass the development of Western Canada and its relationship to the rest of Canada
- 4 | gain an appreciation for the social, economic, political and religious influences that Canadian History 20
- 5 | **Credits:** 3
- 6 | utilize a historical perspective to understand the complex series of events (beginning in 1815) that encompassed the development of Canada into a modern nation

Western World History 30

- 1 | **Credits:** 3
- 2 | **Prerequisites:**
 - a | none
- 3 | use methods of inquiry to understand, analyse and evaluate historical data and information effectively
- 4 | apply these methods of inquiry to the significant historical events and concepts that shaped the development of Western Europe

Intercultural Studies 15

- 1 | **Credits:** 3
- 2 | **Prerequisites:**
 - a | appropriate approvals for the student's international experience
- 3 | learn about intercultural theory and its application in everyday situations
- 4 | extend and refine intercultural skills in preparation for participation in international travel
- 5 | reflect upon international experience and its relationship to becoming a global citizen

Military Studies 15, 25, 35

- 1 | **Credits:** 3 or 5 each
- 2 | **Prerequisites:**
 - a | none for 15 level
 - b | preceding levels for 25 and 35 courses required
- 3 | examine the concepts of war and peace from historical and contemporary contexts
- 4 | inquire into the social, political, environmental and economic factors that influence military activity
- 5 | encounter multiple perspectives on war and peace through personal and collective stories and how these memories influence understanding of identity and community

Social Science complementary courses do **NOT** replace the required Social Studies courses for a Diploma or Certificate of High School Achievement.

Social Science complementary courses with an International focus may be used to meet part of the requirements for a [CBE International Certificate](#).

Social Science
complementary
courses do **NOT**
replace the required
Social Studies
courses for a
Diploma or
Certificate of High
School Achievement.

Social Science
complementary
courses with an
International focus
may be used to meet
part of the
requirements for a
[CBE International
Certificate](#).

Philosophy

Origins of Western Philosophy 20

- 1 | **Credits:** 3
- 2 | **Prerequisites:**
 - a | none
- 3 | examine the need and purpose of philosophy, as well as the influence of early philosophers on our current view of humanity and its place in the universe
- 4 | compare various philosophies and consider how they influence your own philosophical thinking

Contemporary Western Philosophy 20

- 1 | **Credits:** 3
- 2 | **Prerequisites:**
 - a | none
- 3 | examine the need and purpose of philosophy and explore the historical roots of modern philosophical thinking
- 4 | explore traditional problems posed by philosophy
- 5 | appreciate the value of philosophical principles in the development of your own philosophical thinking

Philosophies of Man 30

- 1 | **Credits:** 3
- 2 | **Prerequisites:**
 - a | none
- 3 | examine the need and purpose of philosophy with a focus on how philosophers address fundamental questions of human life
- 4 | critically analyse your individual outlook, knowledge and belief systems

Political Science

Political Thinking 20

- 1 | **Credits:** 3
- 2 | **Prerequisites:**
 - a | none
- 3 | understand the process of political decision making in a Canadian context from a historical, political, and economic perspective
- 4 | develop an awareness of differing political points of view and how these points of view influence individual political beliefs
- 5 | examine the relationship between freedom and responsibility in the functioning of a democratic society

Comparative Government 20

- 1 | **Credits:** 3
- 2 | **Prerequisites:**
 - a | none
- 3 | compare and contrast the political systems of Canada with those of the United States, United Kingdom and the former USSR

GO FOR IT |

Social Sciences Complementary Courses

Social Science complementary courses do **NOT** replace the required Social Studies courses for a Diploma or Certificate of High School Achievement.

Social Science complementary courses with an International focus may be used to meet part of the requirements for a [CBE International Certificate](#).

International Politics 30

- 1 | **Credits:** 3
- 2 | **Prerequisites:**
 - a | none
- 3 | develop an understanding of the importance of various political ideologies on international relations in the interactions between countries from a historical and modern perspective
- 4 | examine forums for peace (e.g. the United Nations) and forces in the economy (e.g. World Bank) that influence international relations

Psychology

General Psychology 20

- 1 | **Credits:** 3
- 2 | **Prerequisites:**
 - a | none
- 3 | gain a broad understanding of the many topics of study in psychology, including learning and thinking, conflicts and disorders, as well as career opportunities

Personal Psychology 20

- 1 | **Credits:** 3
- 2 | **Prerequisites:**
 - a | none
- 3 | explore psychology from the perspective of the individual in greater depth, with a focus on elements of personality, behaviour, intelligence and perception

Experimental Psychology 30

- 1 | **Credits:** 3
 - a | none
- 2 | expand research and data analysis skills using methods situated within the field of psychology
- 3 | inquire into issues of importance to psychologists and design a research project

Abnormal Psychology 35

- 1 | **Credits:** 3
- 2 | **Prerequisites:**
 - a | Personal Psychology 20 or General Psychology 20
- 3 | learn about the historical emergence of the field of abnormal psychology and the accompanying theories to describe the causes of abnormal behaviour, including biological and environmental factors

Learn more | visit [Unique Opportunities and Off-campus Education](#)

Religious Studies

Religious Ethics 20

- 1 | **Credits:** 3
- 2 | **Prerequisites:**
 - a | none
- 3 | explore the meaning of ethics, morals and values from a religious point of view
- 4 | reflect upon personal belief systems within the context of significant issues in modern life

Religious Meanings 20

- 1 | **Credits:** 3
- 2 | **Prerequisites:**
 - a | none
- 3 | explore key issues in religious studies such as basic needs in human life, the meaning of life, the influence of faith in everyday life and the formation of identity
- 4 | **Credits:** 3
- 5 | **Prerequisites:**
 - a | none
- 6 | understand the historical development of religion and survey the beliefs and practices of major religions around the world

Sociology

General Sociology 20

- 1 | **Credits:** 3
- 2 | **Prerequisites:**
 - a | none
- 3 | explore the themes of culture, society and class as they relate to the discipline of sociology
- 4 | learn about research methods in sociology and how to analyze society from an objective point of view

Sociological Institutions 20

- 1 | **Credits:** 3
- 2 | **Prerequisites:**
 - a | none
- 3 | learn about social institutions and how organization and power structures impact and influence the interactions of individuals in society
- 4 | explore elements of social behaviour, deviance and control within historical and modern examples

Applied Sociology 30

- 1 | **Credits:** 3
- 2 | **Prerequisites:**
 - a | none
- 3 | learn how sociologists practice their discipline within an everyday context with a focus on societal and personal issues
- 4 | consider the influence of social movements of cultural change

Wellness

Yoga 15, 25, 35

- 1 | **Credits:** 3 or 5 each
- 2 | **Prerequisites:**
 - a | Yoga 15 none
 - b | preceding courses required for 25 and 35
- 3 | perform the postures (asanas), breathing techniques and relaxation techniques of yoga practice
- 4 | develop personal management skills and the knowledge to benefit personally from a regular individualized yoga program
- 5 | acquire and apply a basic understanding of anatomy and physiology relevant to yoga, and understand the historical roots of yoga as an art, science and philosophy

Social Science complementary courses do **NOT** replace the required Social Studies courses for a Diploma or Certificate of High School Achievement.

Social Science complementary courses with an International focus may be used to meet part of the requirements for a [CBE International Certificate](#).

Yoga courses do **NOT** replace the required grade 10 Physical Education course for a Diploma or Certificate of High School Achievement.

Unique Pathways & Off-campus Education

We collaborate with post-secondary institutions, industry partners and community organizations to offer a wide-range of unique opportunities for students. These range from practical, hands-on learning experiences in Exploratory programs to Dual Credit courses and programs that allow students to participate in post-secondary learning with the support of a supervising CBE teacher. These programs allow students to complete high school their own way, and set students up for future success by easing the transition to post-secondary learning and/or the workplace.

Alternative High School

You may be considering a change in schools or moving into Calgary. You may thrive in a smaller, more informal and highly personalized setting such as the one offered at Alternative High School. Unique features of Alternative's program include:

- 1 | flexible timetabling
- 2 | format that emphasizes student choice and responsibility
- 3 | an inclusive, collaborative culture that celebrates and supports all
- 4 | accepts applications all year
- 5 | **Learn more** | link to the [Alternative High School](#) website

CBe-learn

- 1 | offers classes from Grade 1 to 12
- 2 | provides a full range of online high school academic and option courses
- 3 | supports students enrolled in other high schools as well as students enrolled entirely at CBe-Learn
- 4 | provides a flexible online learning environment for students wishing to study online
- 5 | **Learn more** | link to the [CBe-learn](#) website



Chinook Learning Services

- 1 | for students completing high school credits or upgrading individual courses
- 2 | offers in-person academic high school courses
- 3 | operates as a school within two CBE high schools:
 - CLS at James Fowler High School (north campus)
 - CLS at Lord Beaverbrook High School (south campus)
- 4 | provides flexible schedules two times a week (for 5-credit courses) and more often for combined courses (usually 8 credits total):
 - mornings & afternoons: for students under 20 years of age as of September 1st
 - evening sessions: available for all students, including those over 20 years of age as of September 1st
- 5 | Learn more | link to [Chinook Learning Services](#)

Discovering Choices

- 1 | continue in school and complete your high school Diploma or Certificate of Achievement through Discovering Choices Outreach Program
- 2 | access services, such as personal and career counselling, conflict resolution, anger management techniques, time management and study skills, parenting skills and learning strategies
- 3 | can be found at 4 locations:
 - a | Start (Bowness) Outreach
 - b | Marlborough (Mall) Outreach
 - c | Calgary Achievement Centre for Youth (CACY)
 - d | Westbrook (Mall) Outreach
- 4 | Learn more | link to [Discovering Choices](#) website

Encore CBE

If you are thinking about returning to high school and have questions, Encore CBE can help you explore options, so you can finish school your way—it's never too late.

- 1 | Learn more | link to [Encore CBE](#)

High Performance Athlete Development Pathway

- 1 | based at Bowness High School and includes other sites such as Olympic Oval, University of Calgary, and Canada Olympic Park
- 2 | explore technical, theoretical, and experiential opportunities while pursuing high performance athletics
- 3 | immerse in a high school community focussed on achieving academic goals
- 4 | Learn more | link to [Unique Pathways & Off-campus Education](#) on the CBE website or visit the [Bowness High School website](#)

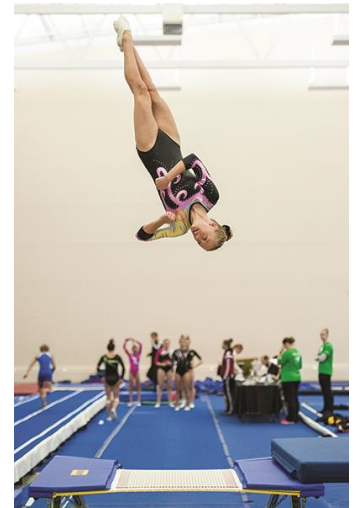

GO FOR IT |

Unique Learning Options

Jack James High School

- 1 | a state of the art, personalized learning community with an emphasis on providing authentic, engaging, hands on, and practical opportunities for all learners
- 2 | students are supported and encouraged to achieve their very best academically and personally each and every day
- 3 | extensive support provided for students transitioning from high school to the workplace or post-secondary institutions
- 4 | **Learn more** | link to [Jack James High School](#)

Language Programs: Immersion and Bilingual

- 1 | **Learn more** | link to the [Languages](#) section of this Guide

Louise Dean School

- 1 | is a school for pregnant and parenting teens where you complete a Diploma or Certificate of Achievement
- 2 | offers a partner service for counselling, financial assistance, childcare and lifestyle supports
- 3 | provides flexible scheduling and personalized learning opportunities classrooms
- 4 | operates a September to June traditional program along with a summer school component
- 5 | enter the program throughout the year
- 6 | **Learn more** | link to the [Louise Dean](#) website



Internationally Recognized Course Offerings

At the high school level, two internationally recognized course offerings are:

- 1 | Advanced Placement (AP)
- 2 | International Baccalaureate (IB)

Each is recognized and respected by universities in Canada and other countries. The school offering AP or IB that you attend is based on the CBE Area where you live. These are courses of choice and there are additional fees for them. Enrolment in AP or IB may affect your course choices and/or course load. Please check with your high school to learn more.

Advanced Placement (AP)

- 1 | explore your unique passions **in one or more** subjects, including English, math, science, social studies, fine arts, languages or computer science
- 2 | study at a university level in a supportive high school environment
- 3 | continue to develop analytical and critical thinking skills
- 4 | prepares you with the knowledge, skills and strategies to successfully write the AP Examination(s) in early May of your Grade 11 and/or Grade 12 years

International Baccalaureate (IB) Programme

- 1 | develops "internationally minded people, who recognizing their common humanity and shared guardianship of the planet, help to create a better and more peaceful world" (IB Learner Profile)
- 2 | encourages participation in creative and service-oriented activities
- 3 | connects learning from various subjects through inquiry (Theory of Knowledge)
- 4 | prepares you with the knowledge, skills and strategies to successfully write the IB Examination(s) in May of your Grade 11 and/or Grade 12 years
- 5 | **Important** | register with your IB school by **March 15** of your Grade 9 year.

*AP Program by Administrative Area

Area	AP High Schools
1	Bowness Robert Thirsk
2	James Fowler William Aberhart
3	Crescent Heights Forest Lawn
4	Nelson Mandela
5	Centennial Lord Beaverbrook Joane Cardinal-Schubert
6	Central Memorial Dr. E.P. Scarlett
7	Ernest Manning Queen Elizabeth

Table 4 | AP Schools by Area

- ***Note** | Talk to your school counsellor or use the [Find a School](#) link to learn about which of these schools offers the AP or IB program(me) for you.
- the New North Calgary High School opening in Sept 2023 will offer AP but the courses are not yet determined

*IB Programme by Geographical Area

Area	High Schools offering IB in English	IB in French	IB Career Programme
1	Sir Winston Churchill		Lester B. Pearson Offers the International Baccalaureate Career Programme and is open to all students in the CBE.
2	John G. Diefenbaker		
3	Consult Find a School		Students in the IB-Career Programme earn a combination Alberta High School Diploma and an IB-CP Certificate in their career field of choice.
4	Lester B. Pearson		
5	Henry Wise Wood		
6	Consult Find a School		
7	Western Canada	Western Canada Offers a full Diploma Programme in French Immersion. Offers combination of French Immersion and IB course certificates.	

Students registered in IB in English and French attend an IB school based on where they live.

Learn more | link to the [IB Registration Information and Expression of Interest](#) form

IB for French Immersion is offered at:

[Western Canada](#)

- offers a full IB Diploma Programme in French Immersion (open to students from all areas in Calgary)
- offers a combination of French Immersion and IB course certificates (open to students who live in the designated areas)

IB Career Programme

[Lester B. Pearson](#)

- offers the opportunity to earn a combination Alberta High School Diploma and an IB-CP Certificate in their career field of choice

Table 5 | IB Programme

Advanced Placement (AP)

Frequently Asked Questions about AP

What is Advanced Placement (AP)?

- 1 | focus on a broad, in-depth study of one or more subjects (English, math, sciences, social studies, fine and performing arts, languages and/or computer science)
- 2 | enables you to pursue college level studies while in a supportive high school environment
 - a | through Grades 10 -12, you will study the Alberta curriculum and the AP curriculum
 - b | there is flexibility to enter AP at any level, depending on your previous learning because AP recognition occurs when you successfully complete a College Board AP Examination in a subject
- 3 | develop the knowledge, skills, and strategies to successfully write the Advanced Placement Examination(s) in early May of your Grade 11 and/or 12 year

Why take an AP class?

- 1 | **Important** | AP refers to the first year college level curriculum at the 30-level; classes at the 10 and 20 levels provide preparation
- 2 | earn advanced credit and/or advanced placement (skip introductory courses) at colleges and universities if you do well on the AP Exam for a subject
 - a | **Learn more** | check university websites and the AP website for details about AP acceptance policies and course equivalents
- 3 | develop skills while in high school to get the most out of university or college even if you do not wish to skip an introductory class in university
- 4 | choose AP classes based on your interests and strengths— there is flexibility to take AP in one or more subject areas
- 5 | study subjects you are passionate about with more depth and breadth

How do I know if I should take AP in one or more subjects?

The Advanced Placement College Board suggests that you:

- 1 | start with your interests – what do you enjoy? What do you want to learn more about?”
- 2 | want a challenge and are willing to do your best work
 - a | “... don't need to be top of your class to be an AP student, but you'll want to be prepared for the AP course you choose” – From: <https://apstudent.collegeboard.org/exploreap/what-it-takes>
- 3 | have “curiosity, creativity and commitment”
- 4 | talk to a counsellor, AP coordinator or a teacher at your AP school about your interests and future plans and ask about your options for learning the skills to help you succeed

How do I register or express my interest in Advanced Placement classes?

- Most high schools offer AP. Students can select AP classes offered at their designated high school or can complete the online transfer form for an AP course that is not offered at their designated school. For a list of schools offering AP classes, view the [CBE AP website](#) for more information.

GO FOR IT |

Internationally Recognized Course Offerings | AP

How will I be evaluated if I am in courses that prepare me to write the AP exam?

- Marks for courses that appear on Alberta Education transcripts are based on standards for the Alberta Education Programs of Studies: your work is evaluated the same way as it is for students in regular classes.

Do I still have to write Diploma Exams and how are AP courses recognized?

- 1 | **AP exams do NOT replace diploma exams.** If the AP course is attached to a diploma course, then writing the diploma exam is required
- 2 | Alberta Education uses official Alberta course names on official transcripts
 - a | For example, English 30-1 is the official course name that will appear on your Alberta Education transcript even if all students in your English 30-1 class will write an AP exam from The College Board
 - b | If you take a locally developed and approved course, such as English 35 (AP), since AP is part of the official course name, it will appear on your transcript
- 3 | AP Exams are administered by the AP College Board in early May, and this is the organization that will provide you with official documentation to use with post-secondary institutions regarding credit for first year courses. You have the choice whether to use the College Board transcripts in addition to your Alberta Education transcripts
- 4 | If you are taking several AP courses, your AP coordinator will assist you with scheduling, and you may write some exams in your Grade 11 year so that you are not overloaded with exams in Grade 12

Is there a cost for Advanced Placement courses?

- 1 | The Advanced Placement College Board sets examination fees - see [The College Board AP Central Exam Calendar and Fees](#)
- 2 | Fees include:
 - a | AP exam fees, exchange rate and administrative fees
 - b | possibly, the purchase of additional texts—talk to the AP Coordinator at your high school for more information

Locally Developed and Approved Courses for Advanced Placement

In combination with the requirements for the Alberta High School Diploma, schools may offer locally developed and approved courses to support you in meeting the requirement for recognition from the Advanced Placement College Board.

Your transcripts from the College Board will contain the official names of Advanced Placement courses. See [Appendix E](#) | Advanced Placement courses offered by CBE schools.

GO FOR IT |

Internationally
Recognized
Course Offerings
| AP

Biology (Advanced) 35

- 1 | Credits: 3
- 2 | Co-requisites:
 - a | Biology 30
- 3 | enrich understanding of complex relationships of four big ideas of biology:
 - a | Evolution: The process of evolution drives the diversity and unity of life.
 - b | Energetics: Biological systems utilize free energy and molecular building blocks to grow, to reproduce and to maintain dynamic homeostasis.
 - c | Information Storage and Transmission: Living systems store, retrieve, transmit and respond to information essential to life processes.
 - d | Systems
 - e | Interactions: Biological systems interact, and these systems and their interactions possess complex properties.
- 4 | enhance analytical and research skills through participations in inquiry-based investigations of the the four big ideas
- 5 | make discoveries and engage in the world critically and analytically; acknowledge the speed at which scientific discoveries and research continuously expand scientific knowledge

Capstone 25, 35

- 1 | Credits: 5 each
- 2 | Prerequisite:
 - a | ELA 20-1 for Capstone 25
 - b | Capstone 25 for the 35 level
- 3 | engage in independent research and in-depth discussions
- 4 | work in collaborative teams to investigate several perspectives of issues
- 5 | write academic papers and present and defend research choices
- 6 | develop diplomacy, consensus, editing and reflection
- 7 | move from collecting and interpreting the work of others to synthesizing collected work with your own original research to develop new understandings of complex issues at the 35-level

Math 31 for AP students taking the AB Calculus AP Exam

- 1 | Credits: 0
- 2 | Co-requisite:
 - a | Math 31 (5 credits)
- 3 | full introduction to Level I university calculus or one semester of first year calculus
- 4 | enrich understanding of the following topics and skills: limits, derivatives, definite integrals and the fundamental Theorem of Calculus

Calculus (Advanced) 35 for AP students taking the BC Calculus Exam

- 1 | Credits: 3
- 2 | Co-requisite:
 - a | Math 31 recommended
- 3 | covers content of a full first year of university calculus
- 4 | enrich understanding of the topics and skills course above, as well as investigating parametric, polar, & vector functions, and series through a multi-representational approach
- 5 | focus on the properties of series

Advanced Placement
complementary
courses do **NOT**
replace the required
core courses for a
Diploma.

GO FOR IT |

Internationally
Recognized
Course Offerings
| AP

Chemistry (Advanced) 35

- 1 | **Credits:** 3
- 2 | **Co-requisites:**
 - a | Chemistry 30
- 3 | enrich understanding of the following topics: atomic structure, intermolecular forces and bonding, gas laws, solutions and stoichiometry, electrochemistry, chemical reactions, kinetics, thermodynamics and equilibrium
- 4 | enhance analytical and research skills through participation in inquiry-based investigations
- 5 | make discoveries, and engage in the world critically and analytically acknowledge the speed with which scientific discoveries and research continuously expand scientific knowledge

English (AP) 35

- 1 | **Credits:** 3
- 2 | **Prerequisite or Co-requisite:**
 - a | English 30-1
- 3 | respond to and communicate comprehension of classic and contemporary American, Canadian, British, and international texts at a first-year university level
- 4 | analyze and synthesize elements of writing styles in order to create and influence meaning in literary texts
- 5 | define, analyze, and apply literary critical theory to provide contextual perspective and to deconstruct the meaning of text
- 6 | engage in major research projects related to the study of literature

Environmental Science (Advanced) 35

- 1 | **Credits:** 5
- 2 | **Prerequisite or Co-requisites:**
 - a | Biology 20 and Math 20
- 3 | understand the interrelationships of the natural world
- 4 | identify and analyze environmental problems both natural and human-made
- 5 | evaluate the risks associated with given environmental problems
- 6 | examine alternative solutions for resolving or preventing environmental problems
- 7 | apply mathematical models in a college level laboratory based science course

European History (AP) 35

- 1 | **Credits:** 5
- 2 | **Prerequisite:**
 - a | none
- 3 | critically analyse and synthesize major themes in European history, politics, economics, and culture (from 1450 to the early 1700s, including the beginning of the French Revolution)
- 4 | gather evidence, including primary sources, using a variety of research tools to express an understanding of and appreciation for multiple perspectives
- 5 | use examples to dissect and trace the development of ethics and social justice from a historical perspective
- 6 | clearly express historical ideas and concepts from an analytical perspective in both discussion and written formats

Advanced Placement
complementary
courses do **NOT**
replace the required
core courses for a
Diploma.

Physics (Advanced) 35

1 | Credits: 5

2 | Prerequisite:

a | Physics 30

- 3 | enrich understanding of the following topics: Newton's Laws, Circular Motion, Torque and Rotational Statics, Oscillations and Gravitations, Fluid Mechanics and Thermal Physics, Electricity and Magnetism, and Waves and Optics
- 4 | enhance analytical and research skills through participation in research projects, field work, and off-campus visits to develop world readiness skills
- 5 | make discoveries and engage in the world critically and analytically
- 6 | acknowledge the speed with which scientific discoveries and research continuously expand scientific knowledge



GO FOR IT |

Internationally Recognized Course Offerings | IB

For more information about the International Baccalaureate (IB) Programme, visit The [International Baccalaureate Organization](#) (IBO)

Remember | The IB Programme is offered in English and French Immersion | see the IB Program by Geographical Area Chart on [the International Course Offerings page in this document](#)

Remember | The IB Career Programme is offered at Lester B. Pearson High School and is open to all students | see [the International Course Offerings page in this document](#)

International Baccalaureate (IB) Programme Frequently Asked Questions about IB

What is the IB Diploma Programme?

- 1 | develops "internationally minded people who, recognizing their common humanity and shared guardianship of the planet, help to create a better and more peaceful world" (IB Mission Statement).
- 2 | encourages participation in creative and service-oriented actions, as well as personal and academic reflection
- 3 | addresses intellectual, social, emotional and physical well-being
- 4 | covers the curriculum required by Alberta Education and the IB programme

Why take IB?

- 1 | plan to prepare for success at university and life by developing intellectual, social, emotional and physical well-being
- 2 | desire a demanding curriculum, like the Diploma Programme, which leads to final IB examinations and a qualification that is welcomed by leading universities around the world
- 3 | receive recognition from institutions of higher education, such as scholarships
 - a | **Learn more** | check university websites and the IBO website for details and recognition of IB credentials

How do I know if I should take IB?

The IBO suggests IB learners strive to be:

- 1 | "inquirers, knowledgeable, thinkers, communicators, principled, open-minded, caring, risk takers, balanced, and reflective"
 - 2 | "internationally minded people who, recognizing their common humanity and shared guardianship of the planet, help to create a better and more peaceful world"
- (From: <https://www.ibo.org/contentassets/fd82f70643ef4086b7d3f292cc214962/learner-profile-en.pdf>)

What are my choices as a candidate for IB?

- 1 | As an *International Baccalaureate Diploma Programme (IBDP) student*, you:
 - a | take one course from each of 6 subject course groups:
 - b | English A
 - c | Language B
 - d | History, Business & Management, Philosophy
 - e | Sciences
 - f | Mathematics
 - g | Visual Arts, Theatre Arts, Film
 - h | 3 and no more than 4 Higher Level (HL) courses
 - i | 3 and no fewer than 2 Standard Level (SL) courses
 - j | 1 elective
 - k | study at least two languages
 - l | engage in independent research through an in-depth study of a question relating to one of the Diploma subjects you are studying--Extended Essay
 - m | inquire into the nature of knowing and learning that unifies the academic disciplines--Theory of Knowledge
 - n | enhance your personal and interpersonal development through
 - **Creativity**—engaging in the Arts and creative thinking
 - **Action**—developing a healthy lifestyle through physical activity
 - **Service**— in the community
 - involve additional hours outside of school to complete CAS
 - o | gain the knowledge, skills and strategies to successfully write the IB exams in May of your Grade 11 and/or Grade 12 year
- 2 | As an *International Baccalaureate Course student*, you:
 - a | receive an IB certificate for each IB course you successfully complete

GO FOR IT |

Internationally
Recognized
Course Offerings
| IB

What is the difference between Standard Level (SL) and Higher Level (HL) IB courses?

- 1 | SL and HL courses have a common core area of study and examination
- 2 | the difference is that there is greater breadth and depth in the optional areas of study in the HL course
- 3 | see the curriculum at www.ibo.org for further details about the differences

How will I be evaluated if I am in courses that prepare me for IB credentials?

Marks for courses that appear on Alberta Education transcripts are based on standards for the Alberta Education Programs of Study: your work is evaluated the same way as it is for students in regular classes.

Do I still have to write Diploma exams and how are IB courses recognized?

- 1 | **IB exams do NOT replace diploma exams.** If an IB course is attached to a diploma course, then writing the diploma exam is required
- 2 | Alberta Education uses official Alberta course names on official student transcripts
 - a | For example, Biology 30 is the official course name that will appear on your Alberta Education transcript even if your Biology 30 class is offered to a group of students in the IB programme
 - b | If you also take a locally developed and approved course, such as Biology 35 (IB), since IB is part of the official course name, it will appear on your transcript
- 3 | To avoid being overloaded with Diploma and IB exams in your Grade 12 year, you take some Diploma courses in both Grades 11 and 12
- 4 | IB Exams are administered by the IBO in May, and the IBO will provide you with official documentation to use with post-secondary institutions

What fees are involved for IB?

Students and/or parents/guardians are responsible for the fees set by the IBO (subject exam fees) and courier costs, including:

- 1 | \$200 for each IB course (for exam and mailing fees)
- 2 | \$25 administrative fee (paid annually)

How do I register as a Diploma Programme student or *Diploma Course* student?

- 1 | as a Grade 9 student, submit your registration information by **March 15** of your Grade 9 year to the high school that offers IB for you
 - a | please use [Find a School](#) to locate the high school that offers IB for you
 - b | please submit only one registration/expression of interest to your IB school
- 2 | **Learn more** | visit the International Baccalaureate page on the CBE website for the [IB Registration Information and Expression of Interest](#) form

IB complementary courses do **NOT** replace the required core courses for an Alberta High School Diploma.

Locally Developed and Approved Courses for the IB Programme

In combination with the requirements for the Alberta High School Diploma, schools may offer locally developed and approved courses to support you in meeting the requirement for recognition from the International Baccalaureate Organization. As well as the courses described below, your IB school may offer -1 enriched academic classes for groups of IB students.

Biology (IB) 25 or 35

- 2 | **Credits:** 3 for 25-level IB SL; 5 for 35-level IB HL
- 3 | **Prerequisites:**
 - a | Science 10 and Math 10C for Biology (IB) 25
 - b | Biology 30 is the prerequisite for Biology (IB) 35
 - c | **Important** | You must be registered in the IB programme to take either of these courses
 - d | **Important** | **You may NOT receive credits in both courses**
- 4 | In Biology (IB) 25, Standard Level (SL) you will:
 - a | develop literacy of statistical analysis for application to laboratory explorations in Biology
 - b | explore the nature of scientific theories; apply advances of technology to understandings of the cell and advances; enhance understanding of key concepts within cell theory
 - c | extend knowledge to the concepts of chemical elements and water, DNA, enzymes, cellular respiration and photosynthesis through application of analytical, experimental and investigative scientific skills
- 5 | In Biology (IB) 35, Higher Level you will also:
 - a | apply statistical analysis to laboratory explorations in Biology.
 - b | study plant science, genetics, neurobiology and human physiology
 - c | engage in an in-depth group research project

Chemistry (IB) 25, 35

- 1 | **Credits:** 5 each
- 2 | **Prerequisites:**
 - a | None for 25 level
 - b | Chemistry 20 or Chemistry (IB) 25 is the prerequisite for Chemistry (IB) 35
 - c | **Important** | You must be registered in the IB Programme in your school to take these courses
- 3 | engage in university level content in Chemistry (possibility of early admission to university and/or earn credit for first year university courses)
- 4 | consists of core topics completed over two years of instruction | Quantitative Chemistry, Atomic Structure, Periodicity, Bonding, Energetics, Kinetics, Equilibrium, Acids and Bases, Oxidation and Reduction, Organic Chemistry, Measurement and Data Processing
- 5 | includes A-G options in addition to core topics | A Modern analytical chemistry; B Human biochemistry; C Chemistry in industry & technology, D Medicine and drugs; E Environmental chemistry; F Food chemistry; G Further organic chemistry
- 6 | at Standard Level (SL) IB, study the core of any two options from A–G Options for 15 hours each
- 7 | at the Higher Level (HL) study any two entire A-G options (that is, the core and the extension material) for 22 hours each
 - a | **Important** | individual teachers select the options from the list above

GO FOR IT |

Internationally Recognized Course Offerings | IB

IB complementary courses do **NOT** replace the required core courses an Alberta High School Diploma.

English (Literature) 35

- 1 | **Credits:** 3 (SL) or 5 (HL)
- 2 | **Co-requisite:**
 - a | ELA 20-1
- 3 | emphasis is placed on exploring the means used by different authors to convey their ideas in the works studied
- 4 | understanding via a comparative framework is emphasized in all parts of the program
- 5 | students will understand and appreciate that engagement with literature is a lifelong learning endeavour that encourages growth, exploration, and adaptation
- 6 | exploration is framed around seven conceptual understandings (Identity, Culture, Creativity, Communication, Perspective, Transformation, and Representation) that structure the teaching and learning.

Math Analysis and Approaches 25, 35

- 1 | **Credits:** 25 (5 credits) 5 (3 credits)
- 2 | **Prerequisites:**
 - a | recommended that students take these courses in the following sequence: Mathematics 10C, Mathematics 20-1, Mathematics 30-1, then Mathematics: analysis and approaches 25 (for SL) or Mathematics: analysis and approaches 35 (for HL)
- 3 | engage in analytical exploration to develop deep understanding of mathematics.
- 4 | construct, communicate, and justify correct mathematical arguments, which is essential in a variety of real life situations.
- 5 | prepare for entry into post-secondary programs that require calculus

Physics (IB) 25, 35

- 1 | **Credits:** 3 or 5 for 25-level or IB SL; 5 for 35-level or IB HL
- 2 | **Prerequisites:**
 - a | successful completion of Science 10, Math 10C for Physics 25;
 - b | successful completion of Physics 30 for 35 level
 - c | must be registered in the IB programme to take either of these courses
 - d | **Important | you may NOT receive credit in both courses**
- 3 | engage in university level content in Physics (possibility for early admission to university and/or earn credit for first year university courses)
- 4 | apply and use scientific concepts, methods, investigations and collaboration to the study of measurement; mechanics; thermal physics; waves; electricity and magnetism; circular motion and gravity; atomic, nuclear and particle physics; and energy production
- 5 | additional topics required at the HL include: wave phenomena; fields, EM Induction; quantum and nuclear physics
- 6 | additional study of one topic for the SL and HL are selected by the teacher from: relativity; engineering physics; communication and imaging; or astrophysics

GO FOR IT |

Internationally Recognized Course Offerings | IB

IB complementary courses do **NOT** replace the required core courses for a Diploma.

Theory of Knowledge (IB) 35

- 1 | **Credits:** 3 or 5
- 2 | **Prerequisites:**
 - a | Grade 11 or 12 students in the full IB Diploma Programme are required to take this course, but schools may admit other students with permission of the principal
 - b | **Important** | the Theory of Knowledge course requires at least 100 hours in the classroom. Schools may provide flexible access to materials and teachers over the two year IB Diploma Programme
- 3 | connect critical approaches to the construction of knowledge, the academic disciplines and the wider world
- 4 | identify and critically examine how individuals and communities construct knowledge
- 5 | analyze the diversity and richness of cultural perspectives, and identify and interpret personal and ideological assumptions
- 6 | uncover and evaluate personal beliefs and assumptions in order to cultivate thoughtfulness, responsibility and purpose
- 7 | understand that knowledge brings responsibility which leads to commitment and action in the world



International Opportunities

CBE high school students are encouraged to be global learners through:

- the CBE International Certificate
- student exchanges

These opportunities as well as international exchanges empower you to move confidently from one cultural setting to another.

CBE International Certificate

The International Certificate is a way of recognizing and valuing the significant work and experiences of an international nature that you accomplish during high school. It is available to all CBE high school students. You may enroll in the International Certificate at any time during a school year.

To achieve an international certificate you will create a final project or portfolio documenting evidence that you successfully completed **all 3 of the required modules** described below.

Module A: International Languages & Cross Cultural Communication

- 1 | explore other languages and develop the skills to build relationships across cultures
- 2 | complete a minimum of 5 credits in second language study

Module B: International Coursework

- 1 | **B 1:** complete minimum of 3 credits in a course with an international focus, other than Social Studies, such as but not limited to Social Sciences Complementary Courses (for details about applicable courses, use the International Certificate link below)
- 2 | **B 2:** complete Social Studies 10-1, 20-1, and 30-1 OR 10-2, 20-2, and 30-2
 - a | equivalencies considered for students in -4 and from outside of Alberta
- 3 | **B 3:** personalize learning and internationalize 3 assignments (not in Social Studies) within your course work
 - a | integrate an international, intercultural, or global perspective into 3 different assignments*

Module C: International Experience

- 1 | participate in at least 3 months of international experiences while completing high school. This may include combinations of local and global opportunities, such as
 - a | student exchanges
 - b | humanitarian projects and international study/work within Canada
 - c | international work, study, and/or travel with school, family, or community groups to better understand another culture
 - d | local initiatives and opportunities, such as school clubs or community organizations, with an international focus (such as but not limited to Amnesty International; Social Justice, International Cultures Club, Global Environment Club, Debate Club, Multicultural Club, Culture Club, Volunteer Club, Newcomers Club)

Learn more | about the International Certificate please check:

- a | with counsellors or the International Student Certificate Coordinator at your high school
- b | our [International Opportunities](#) page on our website
- c | or email CBE Global Learning: internationalstudents@cbe.ab.ca

Student Exchanges

Are you interested in learning from travel? Explore opportunities to travel in Canada and internationally.

Learn more | visit [International Opportunities](#) on our website

Summer School

Students attend summer school for many reasons:

- 1 | upgrading
- 2 | taking courses to create space in their schedules
- 3 | credit completion
- 4 | gaining valuable work experience while earning credits

In summer school, you can:

- 1 | complete a 5-credit high school course in July
- 2 | choose from a variety of 10, 20, and 30-level subjects
 - a | **Important** | Provincial Diploma Exams occur the first two weeks of August
 - b | Diploma Exam schedules are subject to change by Alberta Education at any time. For up-to-date information related to Diploma Exam dates, please check the Alberta Education Diploma General Information Bulletin

Grades 10 to 12 Summer School is available at:

- 1 | [Chinook Learning Services](#) offers in-person high school courses in the mornings at multiple CBE high schools for your convenience. Students may also enrol in summer Work Experience and/or RAP with Chinook
- 2 | [Unique Pathways](#) programming is offered during July, including Dual Credit, Exploratory and Internships
- 3 | [CBe-learn](#) offers online high school courses.
- 4 | [Career and Technology Centre \(CTC\)](#) at Lord Shaughnessy High School offers a variety of Career and Technology Studies courses over the summer

Note: Grade 9 going into Grade 10 students are only permitted to take Math 15 in Summer School.

Register | in the Spring of the current school year

Learn More | use the links above and talk to your counsellor for more details



Awards and Scholarships

Every CBE high school offers specific awards to their students to recognize outstanding achievements, accomplishments, and contributions. There are awards for academics, complementary subjects, athletics, citizenship and leadership.

As well as awards offered by individual schools, many scholarships are offered to you at a district and provincial level.

[Awards and Scholarships on our website.](#)

Provincial Scholarships

The [Alexander Rutherford Scholarship](#) allows you, as an Alberta student to earn up to \$2,500 towards post-secondary studies based on your high school marks in grade 10, 11 and 12.

Learn more | details about other provincial scholarships and criteria for the Alexander Rutherford Scholarship application, check the link to:

[Alberta Learning Information Systems.](#)

CBE District Scholarships

At a district level, [EducationMatters](#) funds a variety of awards, scholarships and bursaries for CBE students.

National Scholarships

[ScholarshipsCanada.com](#) has an extensive list of scholarships.

At your high school, counsellors and career practitioners are available to support you in finding out more about the scholarships, bursaries and awards for which you might want to apply.



Appendices

Appendix A | Possible Course Sequences for a Certificate of High School Achievement

Note for following Samples A, B, C, D and E

- 1 | All courses are 5 credits unless otherwise indicated.
- 2 | Shading indicates minimum course requirements for a Certificate of High School Achievement.
- 3 | Complementary courses include courses in the following:
 - a | Knowledge and Employability Occupational Courses (including a safety course)
 - b | Knowledge and Employability Workplace Practicum
 - c | Career and Technology Studies (CTS)
 - d | Fine Arts – Art, Drama or Music
 - e | Green Certificate Program Specialization
 - f | Physical Education 20 and/or 30
 - g | Registered Apprenticeship Program
 - h | Second Languages
 - i | Work Experience
- 4 | Students may enrol in Work Experience 35 or Workplace Practicum 30-4 with one or Workplace Readiness 10-4 or HCS3000 as a prerequisite.

Sample A

The school is on a semester system.

The student's goal is to earn a Certificate of High School Achievement in two years of high school.

YEAR 1		YEAR 2		Credits
Semester 1	Semester 2	Semester 1	Semester 2	
English Language Arts 10-4	Science 14 or 10-4	English Language Arts 20-4	English Language Arts 30-4	20
Mathematics 10-4	Social Studies 10-4	Social Studies 20-4	Science 20-4	20
Physical Education 10 (3 credits) + CALM (3 credits)	Complementary Course – Workplace Readiness 10-4	Complementary Course – Occupational Course 20-4	Complementary Course – Occupational Course 30-4	21
Complementary Course – Occupational Course 10-4	Complementary Course – Work Experience 15	Mathematics 20-4	Complementary Course – Workplace Practicum 30-4	20
21	20	20	20	81

Table 6 | Sample A Possible Course Sequences for a Certificate of High School Achievement

From: "Appendix F: Examples of Senior High School Implementation Strategies." [Knowledge and Employability Courses Handbook](#). Alberta Education, revised 2013, 32-36.

Sample B

The school is on a semester system.
The student's goals include:

- a | leaving the second semester of Year 3 to start employment or upgrading, if necessary, for continuing education and training opportunities requirements
- b | earning a Certificate of High School Achievement in three years of high school

YEAR 1		YEAR 2		YEAR 3		Credits
Semester 1	Semester 2	Semester 1	Semester 2	Semester 1	Semester 2	
English Language Arts 10-4	Social Studies 10-4	English Language Arts 20-4	Science 20-4	English Language Arts 30-4		25
Mathematics 10-4	Science 14 or 10-4	Mathematics 20-4	Social Studies 20-4	Complementary Course – Occupational Course 30-4		25
Physical Education 10 (3 credits) + Complementary Course (3 credits)	Complementary Course – Occupational Course 10-4	Complementary Course – Occupational Course 20-4	Complementary Course – Occupational Course 20-4	Complementary Course – Workplace Practicum 30-4		26
Complementary Course – Occupational Course 10-4	CALM (3 credits) + HCS3000 (1 credit) + CTR1110 (1 credit)	Complementary Course – Workplace Practicum 20-4	Complementary Course – Workplace Practicum 20-4			20
21	20	20	20	15		96

Table 7 | Sample B Possible Course Sequence for a Certificate of High School Achievement

- 1 | All courses are 5 credits unless otherwise indicated.
- 2 | Shading indicates minimum course requirements for a Certificate of High School Achievement.

From: "Appendix F: Examples of Senior High School Implementation Strategies." [Knowledge and Employability Courses Handbook](#). Alberta Education, revised 2013, 32-36.

Sample C

The school is on a semester system.
The student's goals include:

- a | leaving the second semester of Year 3 to start employment or upgrading, if necessary, for continuing education and training opportunities requirements
- b | taking English Language Arts and Mathematics for the full year for Grade 10 and Grade 11
- c | earning a Certificate of High School Achievement in three years of high school

YEAR 1		YEAR 2		YEAR 3		Credits
Semester 1	Semester 2	Semester 1	Semester 2	Semester 1	Semester 2	
English Language Arts 10-4 Mathematics 10-4	English Language Arts 10-4 Mathematics 10-4	English Language Arts 20-4 Mathematics 20-4	English Language Arts 20-4 Mathematics 20-4	English Language Arts 30-4		25
Social Studies 10-4	Science 14 or 10-4 and Science 20-4	Social Studies 20-4	Science 20-4	Complementary Course – Occupational Course 30-4		25
Physical Education 10 (5 credits)	Complementary Course – Occupational Course 10-4	Complementary Course – Occupational Course 20-4	Complementary Course – Occupational Course 20-4	Complementary Course – Workplace Practicum 30-4		25
Complementary Course – Occupational Course 10-4	CALM (3 credits) + HCS3000 (1 credit) + CTR1110 (1 credit)	Complementary Course – Workplace Practicum 20-4	Complementary Course – Workplace Practicum 20-4			20
20	20	20	20	15		95

Table 8 | Sample C Possible Course Sequence for a Certificate of High School Achievement

- 1 | All courses are 5 credits unless otherwise indicated.
- 2 | Shading indicates minimum course requirements for a Certificate of High School Achievement.

From: "Appendix F: Examples of Senior High School Implementation Strategies." [Knowledge and Employability Courses Handbook](#) Alberta Education, revised 2013, 32-36.

Sample D

The school is on a semester system.
The student's goals include:

- a | taking a combination of Knowledge and Employability and other courses
- b | transitioning from an initial goal of earning a Certificate of High School Achievement to achieving an Alberta High School Diploma in four years of high school

YEAR 1		YEAR 2		YEAR 3		YEAR 4	Credits
Semester 1	Semester 2	Semester 1	Semester 2	Semester 1	Semester 2	Semester 1	
Mathematics 10-4	Science 14 or 10-4	Mathematics 20-4	Science 24 or 20-4	English Language Arts 30-4	English Language Arts 20-2	English Language Arts 30-2	35
Social Studies 10-4	English Language Arts 10-4	English Language Arts 20-4	Social Studies 20-4	Social Studies 20-2	Mathematics 20-3	Social Studies 30-2	35
Complementary Course – Workplace Readiness 10-4	Complementary Course – Occupational Course 10-4	Complementary Course – Occupational Course 20-4	Complementary Course – Occupational Course 30-4	Complementary Course – Work Experience 35	Science 24		30
Complementary Course – Occupational Course 10-4	Physical Education 10 (3 credits) + Complementary Course (3 credits)	CALM (3 credits) + Complementary Course (3 credits)	Complementary Course – Workplace Practicum 30-4	Complementary Course – Work Experience 35			27
20	21	21	20	15	10		127

Table 9 | Sample D Possible Course Sequence for a Certificate of High School Achievement

Important | The student has completed his or her requirements for the Certificate of High School Achievement after the first semester of the third year.

- 1 | All courses are 5 credits unless otherwise indicated.
- 2 | Shading indicates minimum course requirements for a Certificate of High School Achievement.

From: "Appendix F: Examples of Senior High School Implementation Strategies." [Knowledge and Employability Courses Handbook](#). Alberta Education, revised 2013, 32-36.

Sample E

The school is on a semester system.
The student's goals include:

- a | taking a combination of Knowledge and Employability and other courses
- b | transitioning from an initial goal of earning a Certificate of High School Achievement to achieving an Alberta High School Diploma in three years of high school

YEAR 1		YEAR 2		YEAR 3		Credits
Semester 1	Semester 2	Semester 1	Semester 2	Semester 1	Semester 2	
Mathematics 10-4	Science 14 or 10-4	Mathematics 20-4	Science 20-4	English Language Arts 20-2	English Language Arts 30-2	30
Physical Education 10 (3 credits) + CALM (3 credits)	English Language Arts 10-4	English Language Arts 20-4	Social Studies 20-4	Social Studies 20-2	Social Studies 30-2	31
Social Studies 10-4	Complementary Course – Occupational Course 10-4	Complementary Course – Occupational Course 20-4	Complementary Course – Occupational Course 30-4	Mathematics 20-4	Science 24	30
Complementary Course – Occupational Course 10-4	Complementary Course – Workplace Readiness 10-4	Complementary Course – Workplace Practicum 20-4	Complementary Course – Workplace Practicum 30-4			20
21	20	20	20	15	15	111

Table 10 | Sample E Possible Course Sequence for a Certificate of High School Achievement

Important | The student has completed his or her requirements for the Certificate of High School Achievement after the first semester of the third year.

Important | The student would need to transfer into English Language Arts 20-2 from English Language Arts 20-4.

- 1 | All courses are 5 credits unless otherwise indicated.
- 2 | Shading indicates minimum course requirements for a Certificate of High School Achievement.

From: "Appendix F: Examples of Senior High School Implementation Strategies." [Knowledge and Employability Courses Handbook](#). Alberta Education, revised 2013, 32-36.

Appendix B | Part 1 | Course Sequences and Transfer Points

Your school will support you in selecting courses that match your goals and learning style. Below, you will find diagrams illustrating course sequences and the transfer points recommended by Alberta Education.

In CBE high schools, meeting with your subject teacher to review your work and the outcomes of a course is the first step in a course sequence transfer process. You may initiate this process, or your teacher may also invite you to do this.

Before any course sequence transfer is finalized, your principal or assistant principal will be brought into the conversation. If you are under eighteen, your parent or guardian will also be part of the discussion.

Part 1 | Alberta Education Recommended Transfer Points

English Language Arts (ELA) Recommended Transfer Points

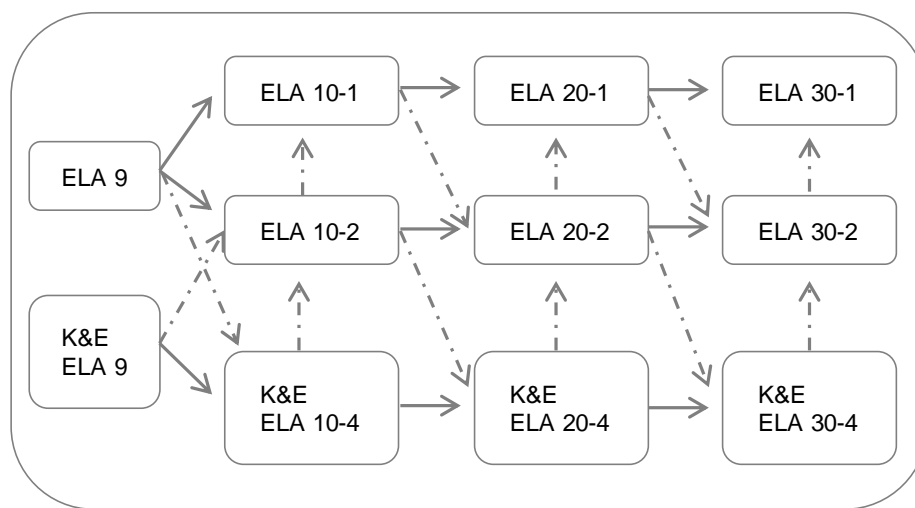

Figure 5 | Recommended English Language Arts Transfer Points

All courses are 5 credits.

In high school, a 50% minimum is required to progress to the next level.

Alberta Education recommends:

- > Typical Progression: usually you take pre-requisites in a course sequence
- - -> Possible Progression: shows transfer points between course sequences

Mathematics (Math) Recommended Transfer Points

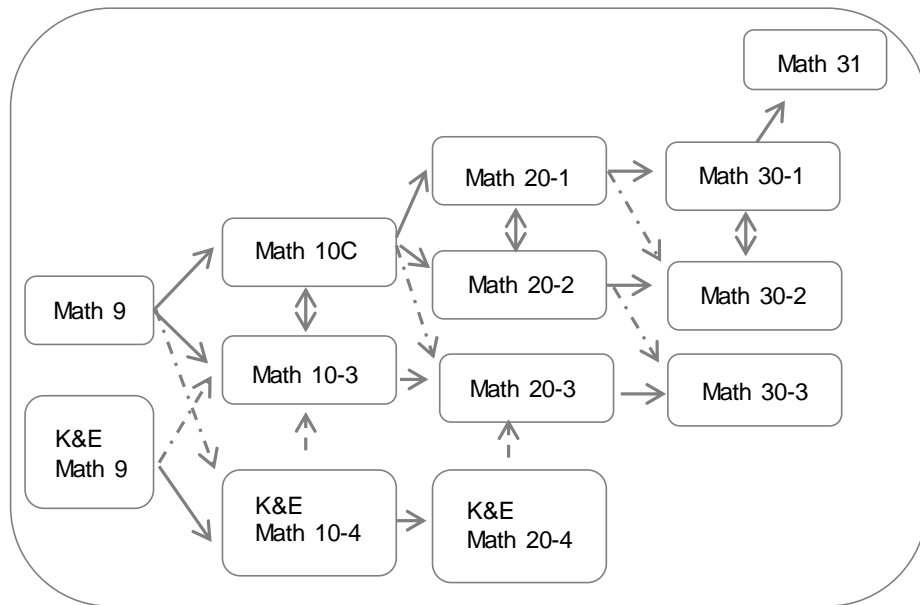

Figure 6 | Recommended Mathematics Transfer Points

All courses are 5 credits.

In high school, a 50% minimum is required to progress to the next level.

Alberta Education recommends:

- > Typical Progression: usually you take pre-requisites in a course sequence
- - -> Possible Progression: shows transfer points between course sequences

Science Recommended Transfer Points

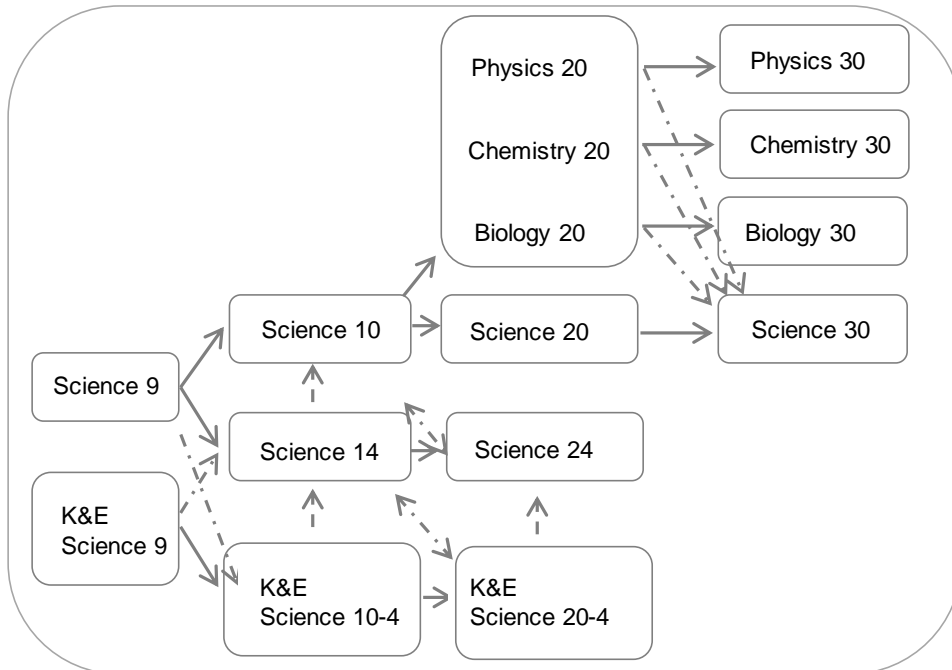

Figure 7 | Recommended Science Transfer Points

Important | If you achieve a final mark of 50% or greater in Biology 20, Chemistry 20, or Physics 20 or Science 20, you may enrol in Science 30.

Important | Although the recommended transfer point from Science 24 is to Science 10, in exceptional cases, students may be placed by the principal in 20-level courses, as serves the student's best interests. This requires a waiver from Alberta Government PASI.

Social Studies (Social) Recommended Transfer Points

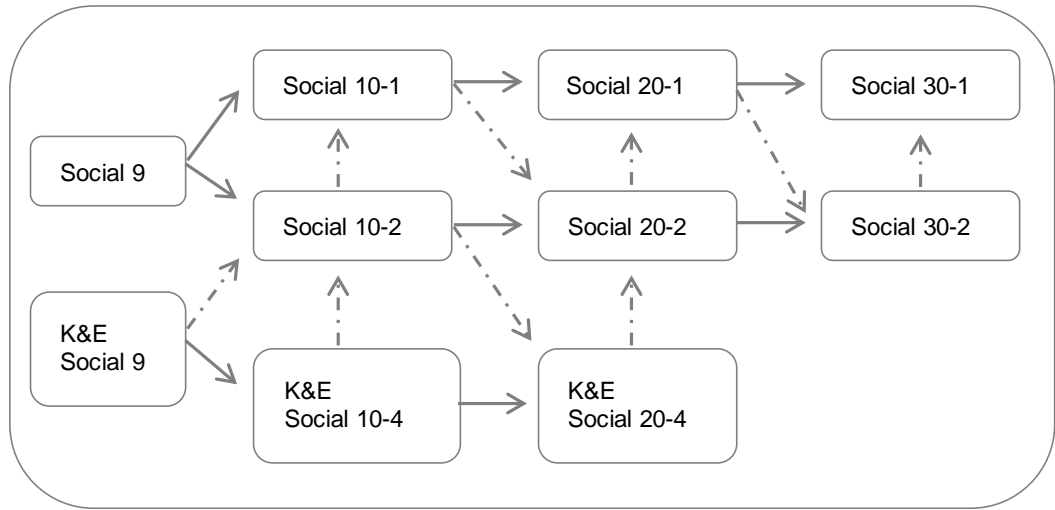

Figure 8 | Recommended Social Studies Transfer Points

FLA 30-1 has a provincial Diploma Exam worth 50% of your final grade. There is no Diploma Exam in FLA 30-2.

Note | Even if you take French Language Arts, you must take English 30-1 or 30-2 to earn a high school Diploma.

All courses are 5 credits.

In high school, a 50% minimum is required to progress to the next level.

Alberta Education recommends:

- > Typical Progression: usually you take pre-requisites in a course sequence
- - -> Possible Progression: shows transfer points between course sequences

French Language Arts (FLA) Recommended Transfer Points

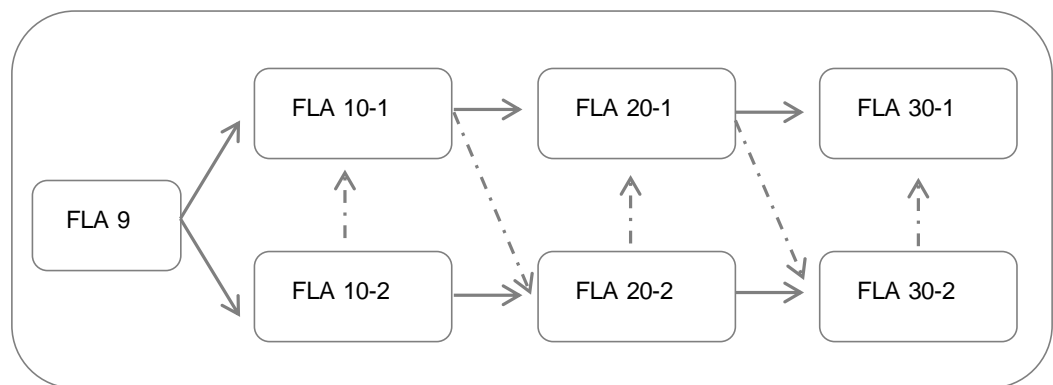

Figure 9 | Recommended (FLA) Course Sequences and Transfer Points

Appendix B | Part 2 | Knowledge and Employability Occupational Course Sequences

K&E occupational courses and CTS courses—Recommended Transfer Points

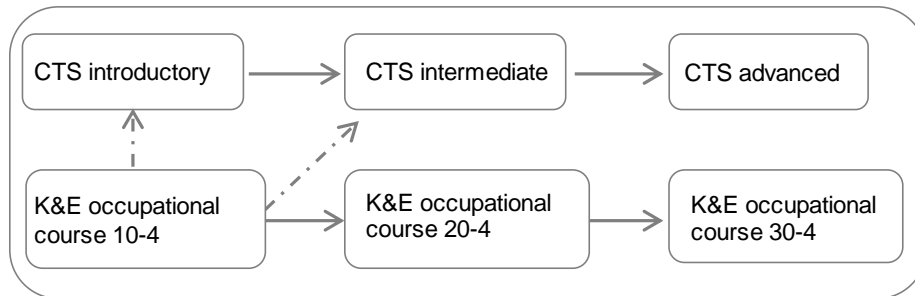

Figure 10 | Recommended Transfer Points for K&E occupational and CTS courses

Alberta Education recommends:

—> Typical Progression: usually you take pre-requisites in a course sequence

- - -> Possible Progression: shows transfer points between course sequences

Transfer from a 10-4 K&E occupational course directly to an intermediate level CTS course may occur when content relevancy and prerequisite requirements are met.

Each K&E occupational course is worth 5 credits. A minimum of 50% is required to progress to the next level. CTS courses are 1-credit courses that are bundled into occupational pathways.

K&E Business Services -4 (Sales & Service; Office Services; Logistics) Sequences

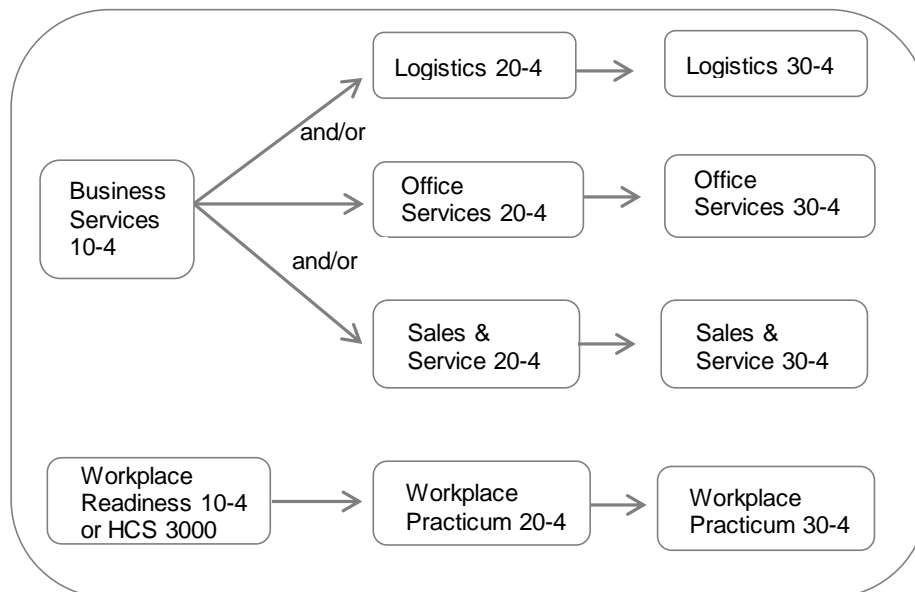

Figure 11 | K&E Business Services -4 Sequences

You may earn credits in more than one Workplace Practicum courses at the 20 and 30 levels.

Learn how | see [Workplace Practicum course sequences and prerequisites.](#)

Each K&E occupational course is worth 5 credits. A minimum of 50% is required to progress to the next level.

You may earn credits in more than one Workplace Practicum courses at the 20 and 30-levels.

Learn how | see [Workplace Practicum course sequences and prerequisites.](#)

K&E Cosmetology -4 (Cosmetology; Esthetics) Sequences

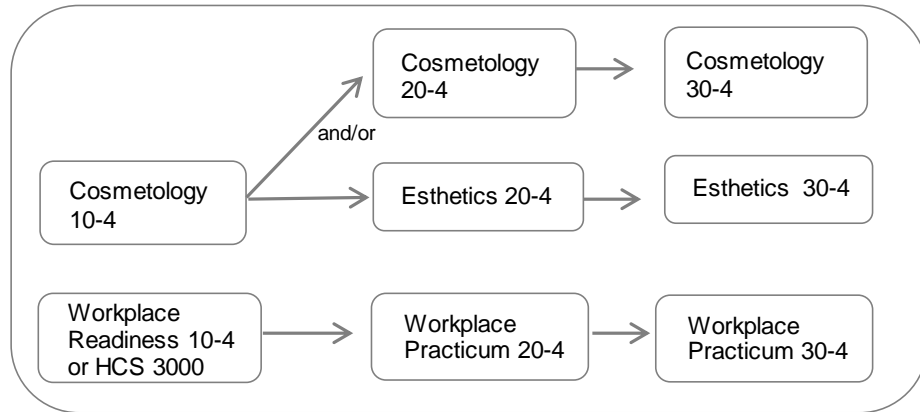

Figure 12 | K&E Cosmetology -4 Sequences

K&E Foods -4 (Food Preparation and Service; Commercial Cooking) Sequences

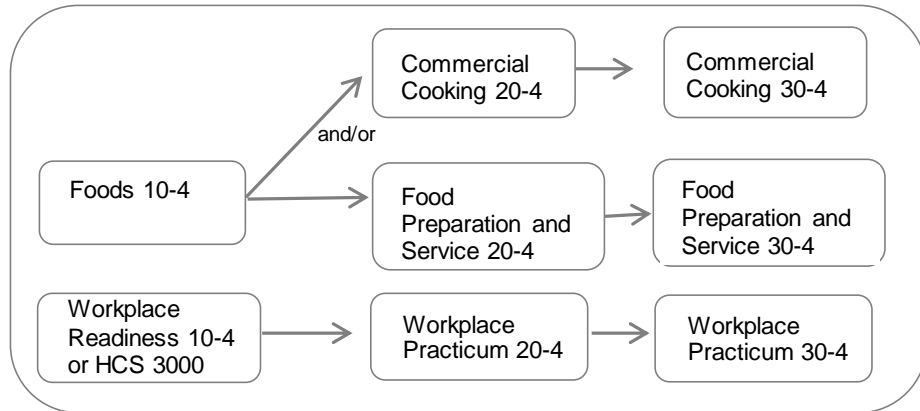

Figure 13 | K&E Foods -4 Sequences

K&E Human Care -4 (Home Care and Child Care) Sequences

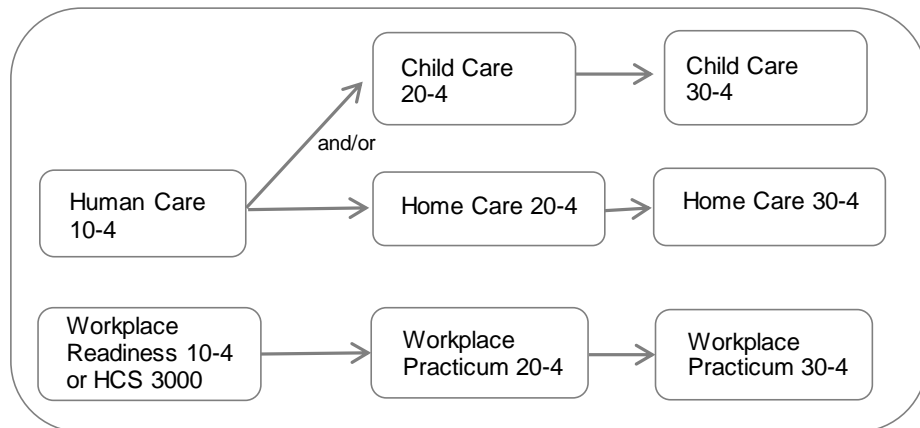

Figure 14 | K&E Human Care -4 Sequences

Each K&E occupational course is worth 5 credits. A minimum of 50% is required to progress to the next level.

You may earn credits in more than one Workplace Practicum courses at the 20 and 30-levels.

Learn how | see [Workplace Practicum course sequences and prerequisites.](#)

K&E Art/Design -4 and Art/Media Communications Sequences

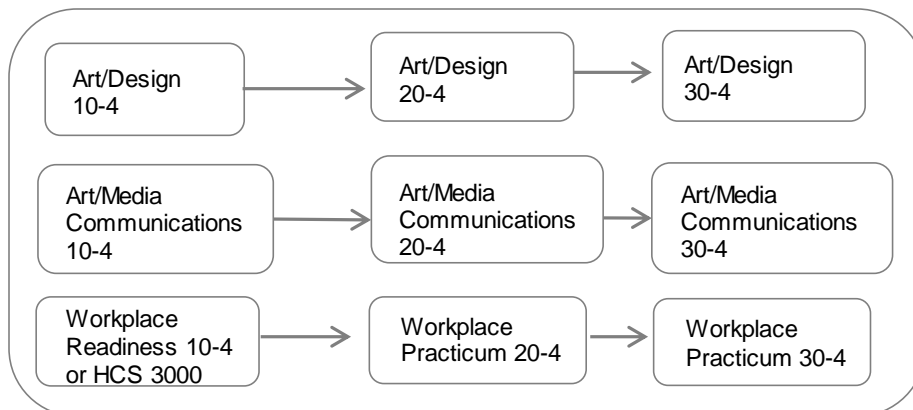

Figure 15 | K&E Art/Design and/or Art/Media -4 Sequences

K&E Fabrics -4 (Industrial Textiles and Fashion Textiles) Sequences

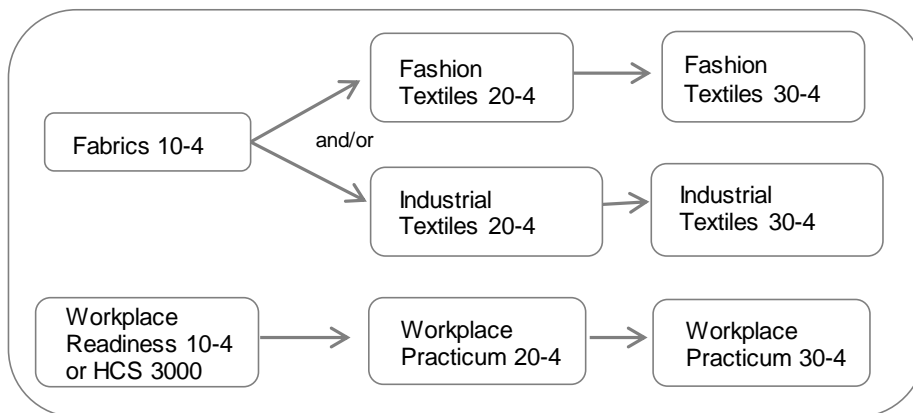

Figure 16 | K&E Fabrics -4 Sequences

K&E Horticulture -4 (Landscaping & Maintenance and Green House & Nursery) Sequences

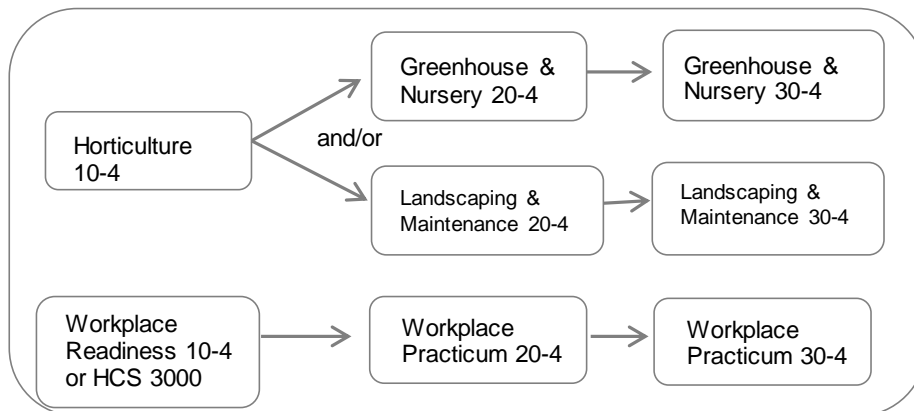

Figure 17 | K&E Horticulture -4 Sequences

Each K&E occupational course is worth 5 credits. A minimum of 50% is required to progress to the next level.

You may earn credits in more than one Workplace Practicum courses at the 20 and 30-levels.

Learn how | see [Workplace Practicum course sequences and prerequisites.](#)

K&E Natural Resources -4 (Agriculture; Forestry, Oil & Gas) Sequences

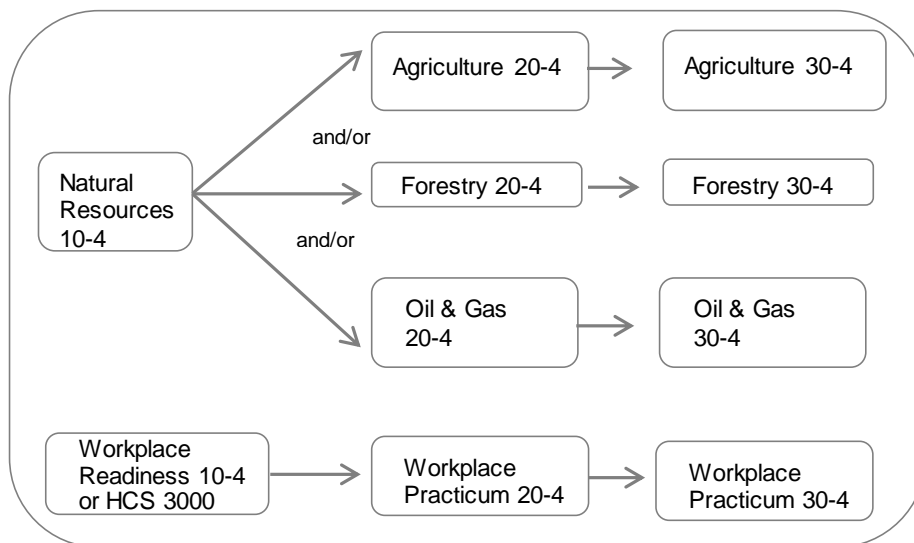

Figure 18 | K&E Natural Resources -4 Sequences

K&E Auto Mechanics -4 (Auto Mechanics and Auto Services) Sequences

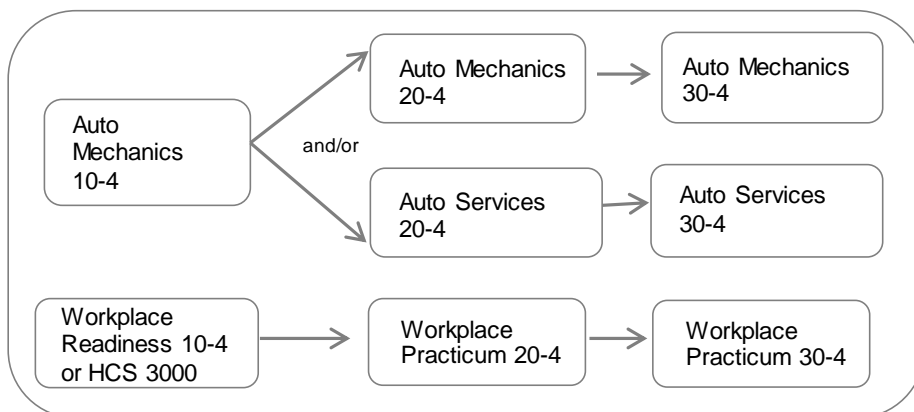

Figure 19 | K&E Auto Mechanics and Services -4 Sequences

K&E Construction -4 (Woodworking & Cabinetry and Woodframe Construction) Sequences

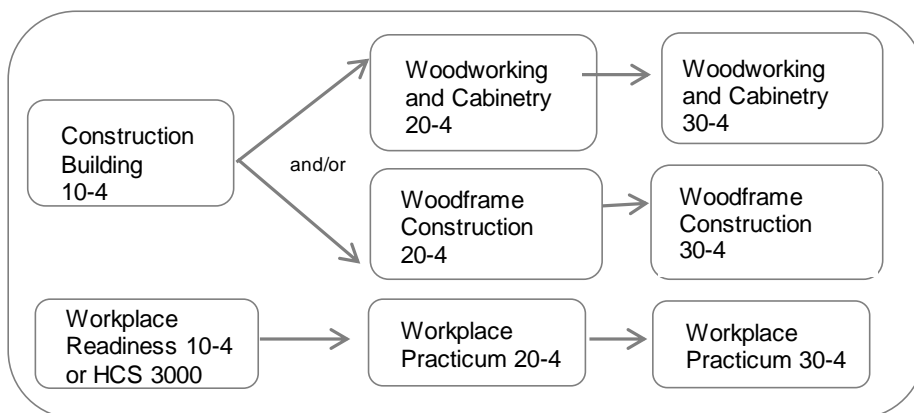

Figure 20 | K&E Construction: Building -4 Sequences

Each K&E occupational course is worth 5 credits. A minimum of 50% is required to progress to the next level.

You may earn credits in more than one Workplace Practicum courses at the 20 and 30-levels.

See the chart below for details about Workplace Practicum course sequences and prerequisites.

K&E Construction -4 (Metal Fabrication and Construction Systems) Sequences

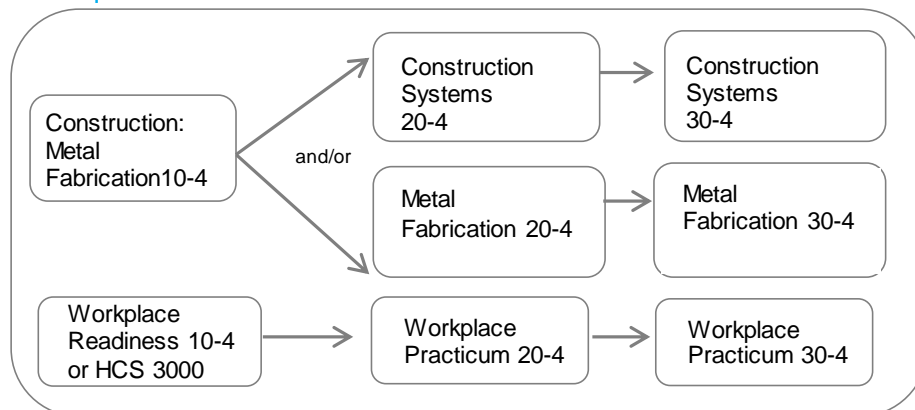

Figure 21 | K&E Construction: Metal Fabrication -4 Sequences

K&E Workplace Readiness -4 and Workplace Practicum Sequences

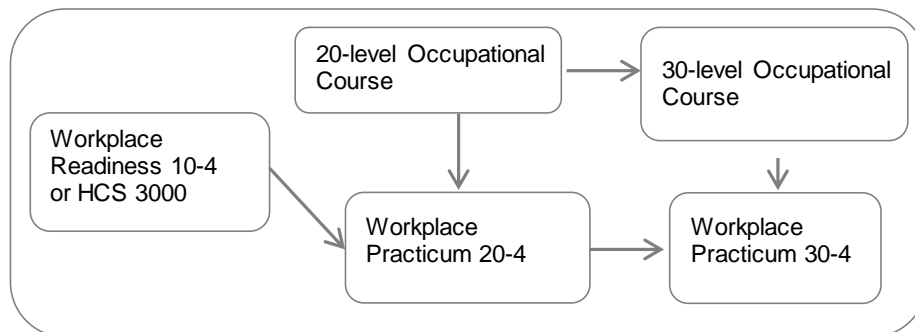

Figure 22 | K&E Workplace Readiness & Practicum - Sequences

Remember |

- 1 | successfully complete Workplace Readiness 10-4 or HSC 3000 and
- 2 | take a 20-4 occupational course while you take a related 20-4 Workplace Practicum course
- 3 | take a 30-4 level occupational course while you take a related 30-4 Workplace Practicum course
- 4 | you may take more than one Workplace Practicum:
 - a | at the 20-level as long as you have an equal number of K&E occupational courses at the 20-level
 - b | at the 30-level as long as you have an equal number of K&E occupational courses at the 30-level

Appendix C | CTS and K&E Occupational Pathways By High School Facilities

Note | If a CTS pathway or K&E occupational course is not available at a student's home high school; it may be available at another high school in the CBE. See the charts on the following pages and talk to a counsellor at your high school for information about availability.

Many Career and Technology Studies (CTS) and Knowledge and Employability (K&E) occupational pathways require specialized facilities. CBE high schools work closely together to support students in accessing pathways that may not be available in their designated home high school.

A variety of CTS pathways and/or K&E occupational courses are available at:

- 1 | a student's designated high school
- 2 | the Career and Technology Centre (CTC) at Lord Shaughnessy
a | **Learn more** | visit the [CTC](#) website
- 3 | [Unique Pathways & Off-campus Education](#)
- 4 | other high schools in the CBE

Important | When a school has the necessary expertise and/or facilities, they offer both CTS courses and K&E occupational courses as per student requests.

On the charts below the following abbreviations are used to describe each of the occupational areas:

- 1 | [BIT: Business, Administration, Finance & Information Technology](#)
- 2 | [HRH: Health, Recreation & Human Services](#)
- 3 | [MDC: Media, Design & Communication Arts](#)
- 4 | [NAT: Natural Resources](#)
- 5 | [TMT: Trades, Manufacturing & Transportation](#)

The level of the pathway offered is indicated by:

- 1 | i/a – means the school offers the occupational pathway at the introductory to the advanced level
- 2 | C – means the school offers courses in the occupational pathway up to and including the Credentialed level
- 3 | AP – means Advance Placement courses offer in CTS programs

Appendix C | CTS and K&E Occupational Pathways By High School Facilities

continued on next page

i/a – introductory to advanced C – credentialed AP – Advanced Placement

Area	This is a representation of programs as they exist at this point. This strategy as a process continues to evolve.	BIT						HRH										MDC				
		Computing Science	Networking	Enterprise & Innovation	Financial Management	Information Processing	Management and Marketing	Cosmetology \ Hairstylist Apprenticeship	Esthetics	Culinary \ Cook Baker Apprenticeship	Personal Foods	Child Dev. Assist	Parenting	Leadership	Legal Studies	Tourism	Sports Medicine/ EM	Sports Performance	HPAD	Communication Technology	Design Studies	Fashion Studies
1	Bowness High School	i/a		i/a	i/a	i/a	i/a	C	i/a	C				i/a	i/a		i/a	i/a	i/a	i/a	i/a	
	Robert Thirsk High School	i/a		i/a		i/a	i/a			C			i/a	i/a		i/a	i/a				i/a	
	Sir Winston Churchill	i/a		i/a	i/a		i/a	i/a	i/a					i/a		i/a	i/a				i/a	i/a
2	James Fowler High School	i/a	i/a	i/a	i/a	i/a	i/a	C	i/a	C	i/a			i/a	i/a		i/a	i/a		i/a	i/a	i/a
	John Diefenbaker High School	i/a	i	i/a	i/a	i/a	i/a				i/a			i/a	i/a	i	i/a	i/a		i/a	i/a	i/a
	William Aberhart High School	AP												i/a			i/a	i/a		i/a	i/a	
3	Crescent Heights High School	i/a									i/a			i/a	i/a		i/a	i/a		i/a	i/a	i/a
	Forest Lawn High School		i/a					C	i/a	C	i/a			i/a	i/a		i/a	i/a		i/a		i/a
	Jack James High School					i/a					C			i/a				i/a		i/a	i/a	i/a
4	Lester B Pearson High School	i/a			i/a		i/a			C				i/a	i/a		i/a	i/a		i/a	i/a	i/a
	Louise Dean School					i/a			i/a			i/a	i/a	i/a						i/a	i/a	i/a
	Nelson Mandela High School	AP			i/a	i/a	i/a			C		i/a		i/a	i/a		i/a	i/a		i/a	i/a	i/a
5	Centennial High School	i/a			i/a			C	i/a	C				i/a			i/a	i/a		i/a		i/a
	Joane Cardinal-Schubert High School	i/a	i/a	i/a	i/a		i/a	C			i/a			i/a	i/a		i/a	i/a		i/a	i/a	
	Lord Beaverbrook High School	i/a		i/a	i/a		i/a	C	i/a	i/a				i/a			i/a	i/a		i/a	i/a	i/a
6	Career and Technology Centre	i/a	i/a		i/a		i/a	C	C	C						i/a				i/a	i/a	
	Central Memorial High School				i/a		i/a								i/a		i/a	i/a		i/a	i/a	i/a
	Dr. E.P. Scarlett High School	i/a									i/a			i/a	i/a		i/a	i/a		i/a	i/a	
	Henry Wise Wood High School	i/a									i/a			i/a			i/a	i/a		i/a	i/a	i/a
7	Ernest Manning High School	i/a		i/a	i/a		i/a							i/a			i/a	i/a		i/a	i/a	
	Queen Elizabeth High School	i/a									i/a			i/a			i/a	i/a		i/a	i/a	
	Western Canada High School	i/a		i/a	i/a	i/a	i/a				i/a			i/a	i/a		i/a	i/a		i/a	i/a	
ALL	CBe-Learn (online)	i/a																				i/a

Table 11 | CTS and K&E Occupational Pathways by High School Facilities

CTS & KE pathway and program offerings may change over time due to staffing, enrollment, equipment and/or facilities. This list is the locations for the 2022-23 school year.

Table continued on next page

Appendix C | CTS and K&E Occupational Pathways By High School Facilities continued

i/a – introductory to advanced C – credentialed AP – Advanced Placement

Area	This is a representation of programs as they exist at this point. This strategy as a process continues to evolve.	NAT						TMT							
		Agriculture	Environmental Stewardship	Forestry	Horticulture	Primary Resources	Wildlife	Auto Body	Auto Service	Aviation	Electro-Technologies	Construction	Building Trades	Logistics	Welding and Metal Fabrication
1	Bowness High School								i/a			i/a	i/a		
	Robert Thirsk High School	i/a	i/a	i/a		i/a	i/a				i/a	i/a			
	Sir Winston Churchill								i/a		i/a				
2	James Fowler High School							i/a	i/a		i/a	i/a	i/a		i/a
	John Diefenbaker High School	i/a	i/a								i/a	i/a			
	William Aberhart High School								C			i/a			
3	Crescent Heights High School		i/a				i/a		i/a			i/a			i/a
	Forest Lawn High School	i/a	i/a				i/a		C			i/a			C
	Jack James High School				i/a			i/a			i/a	i/a	i/a		
4	Lester B. Pearson High School											i/a			
	Louise Dean School														
	Nelson Mandela High School		i/a							i/a	i/a				
5	Centennial High School											i/a			
	Joane Cardinal Schubert High School	i/a	i/a	i/a		i/a	i/a					i/a			
	Lord Beaverbrook High School							i/a	i/a			i/a	i/a		i/a
6	Career and Technology Centre		i/a			i/a		C			C	i/a			C
	Central Memorial High School								C		i/a	i/a			
	Dr. E.P. Scarlett High School								i/a			i/a			
	Henry Wise Wood High School											i/a			
7	Ernest Manning High School										i/a	i/a			
	Queen Elizabeth High School											i/a			
	Western Canada High School										i/a				
ALL	CBe-Learn (online)	i/a	i/a	i/a	i/a	i/a	i/a							i/a	

Innovation Technology Courses

Innovation Technology courses focus on a variety of STEM concepts. These classes expose students to a broad range of knowledge and technical skills using modern and emerging technologies such as 3D-printers, laser cutters, microcontrollers, electronics, robotics, and more.

The course name, specific skills and concepts, credit structure, equipment and technology utilized in innovation technology courses may vary from school to school.

Common names for Innovation technology courses include Design Innovation, Robotics, Engineering Studies, etc.

Check individual high school websites to determine the Innovation Technology courses offered at each location.

Table 11 continued : CTS and K&E Occupational Pathways by High School Facilities

CTS & KE pathway and program offerings may change over time due to staffing, enrollment, equipment and/or facilities. This list is the locations for the 2022-23 school year.

Appendix D | Course Challenge – Questions and Answers

Note | Credit in diploma examination courses can be achieved only through a combination of the school-awarded mark (worth 70%) and the diploma examination mark (worth 30%).

Course challenges in Diploma Exam courses apply ONLY to school-awarded marks for courses and, therefore, **will NOT result in final course marks or credits until after the Diploma Exams are successfully completed**

What is a course challenge?

- 1 | Instead of taking the course, you earn credits for a course when you demonstrate that you have acquired the knowledge, skills and attitudes for a course by Alberta Education.
- 2 | A course challenge involves more than a test. It includes a variety of tasks to assess your achievement of the depth and breadth of the outcomes of an entire course.
- 3 | In CBE high schools, a course challenge has 3 required components: a demonstration, a formal interview and a formal examination.

You must successfully complete **all 3 parts**:

- 1 | a **demonstration** must include some of the following: a portfolio of work whose components and formats are specified by the subject area; project study report; performance-based tasks with a focus on both process and product; oral presentation for languages; and depending on the course, appropriate safety procedures
- 2 | an **interview** that may be conducted by one or more teachers
- 3 | a **formal examination** may include one or more of the following: a multiple choice test; an oral defence; a written test, if writing has not been a component of the demonstration; a polished performance and a skilled task

- 4 | All evaluation is done by a certified teacher with expertise in the subject and COURSE. From: Calgary Board of Education Administrative Regulation 6021: Course Challenge

What is the purpose of a course challenge?

- 1 | A course challenge is intended to:
 - a | meet your diverse learning needs
 - b | encourage ownership of your learning
 - c | acknowledge the learning that you acquire in a variety of settings, not necessarily limited to schools

What steps do I need to take if I plan to challenge a course?

- 1 | make an appointment and meet with your school principal
- 2 | provide evidence of readiness to challenge a course (such as a portfolio, documentation of work and/or experience related to the course)
- 3 | check the Alberta Program of Studies to make sure that you are confident about being evaluated on all of the course outcomes
 - a | **Important** | based on your meeting, your principal will decide if the course challenge will proceed

What are the limits and exceptions to course challenges?

- 1 | The course challenge applies to non-diploma examination courses and only to the school awarded mark of diploma exam courses. If you challenge a non-diploma course, you will be given a final course mark, and, if successful, credits in that course.
- 2 | You may **NOT** initiate a course challenge in a lower level sequence if you have already completed a course in a higher level sequence.
 - a | Example 1: if you earned credit in Math 30-1, you cannot challenge Math 30-2
 - b | Example 2: if you earned credit in FSL 30-9Y, you cannot challenge FSL 30-3Y
- 3 | The following courses are excluded from the challenge provision:
 - a | Agriculture Safety (AGR3000)
 - b | all Green Certificate Program courses
 - c | all Registered Apprenticeship Program (RAP) courses
 - d | Career and Technology Studies (CTS) courses completed in grades 7, 8 and 9
 - e | Career Internship 10
 - f | locally developed/acquired and authorized courses, with the exception of locally developed language courses
 - g | Special Projects 10, 20 and 30
 - h | Work Experience 15, 25 and 35
 - i | Workplace Practicum 20-4 and 30-4
 - j | Workplace Readiness 10-4
 - k | Workplace Safety Systems (HCS3000)

Typically, in what subjects do course challenges occur?

Most course challenges occur in language courses as you may have prior learning experiences with French or another international language. In a language course challenge, you perform oral, written, listening and reading comprehension tasks, as well as show samples of your work. The quality of your performance and work are evaluated by a certificated teacher of the subject.

What happens if I successfully challenge a grade 12 class?

- 1 | The mark for the Grade 12 class and the credits will appear on your transcript.
- 2 | The prerequisites for the Grade 12 class will be waived, and you will receive credits for the previous classes in the sequence.
 - a | Your mark for the previous classes will be recorded as "P" for pass.
 - b | If the class was a Language class, the Grade 12 course mark can be used for the Grade 12 Rutherford Scholarship. Because previous classes are recorded as "P," you will not have marks for grade 10 and 11 awards.

What happens if I am unsuccessful in the course challenge?

- 1 | You can only attempt a particular course challenge once.
- 2 | If you are unsuccessful or if you want to raise your mark, you need to take the course. If the course has prerequisites, you must successfully complete those first.

Appendix E | Advanced Placement (AP) Courses by School and CBE Area

- *Note | Talk to your school administrator or use the [Find a School](#) link to learn about which of these schools offers AP for

Advanced Placement schools submit detailed course outlines to the College Board for approval.

There are more College Board [AP courses](#) than those listed. Depending on your interests, initiative, or previous studies, you may be able to write AP exams for courses beyond those listed. Talk to your AP coordinator about deadlines for these possibilities.

Area	High School	College Board AP Courses Arts, English, History & Social Sciences	College Board AP Courses Math & Computer Science, World Languages & Cultures	College Board AP Courses Sciences
1	Bowness	AP European History AP English Literature & Composition	AP Calculus AB	AP Biology AP Chemistry AP Computer Science
	Robert Thirsk	AP English Literature & Composition AP European History AP Studio Art Drawing AP Studio Art 2-D Design AP Studio Art 3-D Design	AP Calculus AB AP Spanish Language & Culture	AP Biology AP Chemistry AP Physics 1 AP Physics 2
2	James Fowler	AP Studio Art Drawing AP Studio Art 2-D Design AP Studio Art 3-D Design AP English Literature & Composition AP Comparative Government & Politics	AP Calculus AB	AP Biology AP Chemistry AP Physics
	William Aberhart	AP English Literature & Composition	AP Calculus AB AP Computer Science A AP French Language & Culture	AP Biology AP Chemistry AP Physics
3	Crescent Heights	AP Studio Art Drawing AP Studio Art 2-D Design AP Studio Art 3-D Design AP English Literature & Composition AP European History	AP Calculus AB	AP Biology AP Chemistry AP Physics 1 AP Physics 2
	Forest Lawn	AP English Literature & Composition AP European History	AP Calculus AB	AP Chemistry

Table 12 | Advanced Placement Courses offered in CBE High School

Table continued on next page

*The New North High School opening in September 2023 will offer Advance Placement but the courses are not yet determined.

Advanced Placement (AP) Courses by School and CBE Area continued from previous page

Area	High School	College Board AP Courses Arts, English, History & Social Sciences	College Board AP Courses Math & Computer Science, World Languages & Cultures	College Board AP Courses Sciences
4	Nelson Mandela	AP English Literature & Composition AP World History AP Comparative Government & Politics AP Art AP Studio Art Drawing AP Studio Art 2-D Design AP Studio Art 3-D Design	AP Calculus AB AP Computer Science A	AP Biology AP Chemistry AP Physics 1 AP Physics 2
5	Centennial	AP English Literature & Composition AP European History	AP Calculus AB	AP Biology AP Chemistry AP Physics 1
	Lord Beaverbrook	AP Drawing AP Studio Art 2-D Design AP Studio Art 3-D Design AP English Literature & Composition AP European History	AP Calculus AB AP Computer Science A	AP Biology AP Chemistry AP Physics 1 AP Physics 2
	Joane Cardinal-Schubert	AP English Literature & Composition AP European History	AP Calculus AB	AP Biology AP Chemistry AP Physics 1 AP Physics 2
6	Central Memorial	AP Studio Art Drawing AP Studio Art 2-D Design AP Studio Art 3-D Design AP English Literature & Composition AP European History AP Psychology	AP Calculus AB	AP Biology AP Chemistry AP Physics 1 AP Physics 2
	Dr. E.P. Scarlett	AP Studio Art Drawing AP Studio Art 2-D Design AP Studio Art 3-D Design AP English Literature & Composition AP European History	AP Calculus AB AP French Language & Culture AP Spanish Language & Culture AP Computer Science Principles AP Music Theory	AP Biology AP Chemistry AP Physics 1 AP Physics 2
7	Ernest Manning	AP Studio Art Drawing AP English Literature & Composition AP European History	AP Calculus AB AP Computer Science A AP Chinese Language & Culture	AP Biology AP Chemistry AP Physics 1
	Queen Elizabeth	AP English Literature & Composition AP European History	AP Calculus AB AP Calculus BC AP Statistics	AP Biology AP Chemistry AP Physics 1 AP Physics 2 AP Physics C: Electricity & Magnetism

2023
2024

Get Ready ▪ Get Set ▪ Go For It

Learn more about high school and plan for your success



Your
Detailed
High School
Course Guide



Calgary Board
of Education